



BEVERAGE DISPENSING EQUIPMENT



BEER • SODA • WATER • WINE • COCKTAILS • COLD COFFEE

■ Terms & Conditions



Terms & Conditions

The CBS commitment:

Canadian Beverage Supply Inc. & Chill-Max Beverage Solutions Inc. have a sole commitment: your needs. We strive to provide the highest level of satisfaction, by taking a personal interest in your beverage dispensing needs. Our family of dedicated employees is anchored by years of experience, ready and able to offer solutions and ideas to your particular dispense application.

How to order:

Orders can be placed online, by phone or email. Please specify quantities, part numbers, and a short description for each item ordered. Method of payment: All orders will be shipped C.O.D. unless prior arrangements have been made with our credit department. C.O.D. orders can be paid with cash, certified cheque, money order, Visa, American Express, Debit Card and MasterCard. Sales taxes shall be in addition to prices quoted, where applicable. All goods are sold F.O.B. at our warehouse loading dock.

Manufacturer's warranty:

Canadian Beverage Supply Inc. & Chill-Max Beverage Solutions Inc. extend the manufacturer's warranty on all products to the original purchaser. Defective parts will be replaced on a no-charge basis, F.O.B. our warehouse and subject to inspection. The manufacturers are not responsible for parts damaged by alteration, unauthorized service, accident or abuse. All labor, freight and/or loss of sales costs are incidental to the warranties and must be borne by the purchaser. Shipping costs to and from our facility is to be paid by the purchaser.

Lost or damaged merchandise:

The responsibility of Canadian Beverage Supply Inc. & Chill-Max Beverage Solutions Inc. ceases upon acceptance of its products by the carrier. Any damage or loss sustained in shipment is the carrier's responsibility. If any items are damaged, do not accept the shipment unless the carrier makes a notation of this on the freight waybill. Immediately request an inspection and file a claim with the carrier.

Return of merchandise:

Do not return any merchandise without prior approval from Canadian Beverage Supply Inc. & Chill-Max Beverage Solutions Inc. Unauthorized return shipments will be refused. Return goods are subject to a minimum 15% handling and restocking charge when returned between 7-14 days from original purchase/ship date. Goods returned after 14 days from original purchase/ship date are subject to a 25% handling and restocking charge. Custom orders, cut tubing or trunkline and non-stock items are subject to 75-100% handling and restocking charges and CBS/Chill-Max reserves the right to refuse return. Freight charges must be prepaid on all return shipments.

It is the policy of Canadian Beverage Supply Inc. & Chill-Max Beverage Solutions LLC. to continuously upgrade the merchandise we sell. Therefore, we reserve the right to change items' specifications and pricing without notice.





DRAUGHT BEVERAGE ENGINE ROOM

Primary Regulators

CHILL-MAX PRIMARY REGULATORS

Product Code	Description
CO882061CM	60lb CO2 Primary Regulator w/ Shut-Off
CO882161CM	160lb CO2 Primary Regulator w/ Shut-Off
CO892060CM	60lb N2 Primary Regulator w/ Shut-Off
CO892160CM	160lb N2 Primary Regulator w/ Shut-Off



CO882161CM

CHILL-MAX PRIMARY REGULATORS WITH GAUGE GUARD

Product Code	Description
CO772061-CMGG	60lb CO2 Primary Regulator w/ Shut-Off & Gauge Guard
CO772161-CMGG	160lb CO2 Primary Regulator w/ Shut-Off & Gauge Guard
CO772060-CMGG	60lb N2 Primary Regulator w/ Shut-Off & Gauge Guard
CO772160-CMGG	160lb N2 Primary Regulator w/ Shut-Off & Gauge Guard



CO772161-CMGG

TAPRITE PRIMARY REGULATORS

Product Code	Description
CO882061T	60lb CO2 Primary Regulator w/ Shut-Off
CO882161T	160lb CO2 Primary Regulator w/ Shut-Off
CO892060T	60lb N2 Primary Regulator w/ Shut-Off
CO892160T	160lb N2 Primary Regulator w/ Shut-Off



TAPRITE PRIMARY REGULATORS WITH GAUGE GUARD

Product Code	Description
CO772061-TGG	60lb CO2 Primary Regulator w/ Shut-Off & Gauge Guard
CO772161-TGG	160lb CO2 Primary Regulator w/ Shut-Off & Gauge Guard
CO772060-TGG	60lb N2 Primary Regulator w/ Shut-Off & Gauge Guard
CO772160-TGG	160lb N2 Primary Regulator w/ Shut-Off & Gauge Guard



PREMIUM METAL PRIMARY REGULATORS

Product Code	Description
CO882061PM	60lb CO2 Primary Regulator w/ Shut-Off
CO882161PM	160lb CO2 Primary Regulator w/ Shut-Off
CO892060PM	60lb N2 Primary Regulator w/ Shut-Off
CO892160PM	160lb N2 Primary Regulator w/ Shut-Off



CO882061PM



CO892060PM

PREMIUM METAL PRIMARY REGULATORS WITH GAUGE GUARD

Product Code	Description
CO772061-PMGG	60lb CO2 Primary Regulator w/ Shut-Off & Gauge Guard
CO772161-PMGG	160lb CO2 Primary Regulator w/ Shut-Off & Gauge Guard
CO772060-PMGG	60lb N2 Primary Regulator w/ Shut-Off & Gauge Guard
CO772160-PMGG	160lb N2 Primary Regulator w/ Shut-Off & Gauge Guard

Secondary Regulators

Chill-Max Secondary Regulators

SECONDARY WALL-MOUNT REGULATORS

Product Code	Description
CO881062CM	60lb Secondary Regulator w/ Shut-Off & 5/16" Barbs
CO881063CM	60lb Secondary Regulator w/ Shut-Off, 5/16" Barbs & Plug
CO881065CM	60lb Secondary Regulator w/ Shut-Off - No Fittings

GANGED SECONDARY WALL-MOUNT REGULATORS

Product Code	Description
CO881260CM	2 x 60lb Secondary Regulator w/ Shut-Off, 5/16" Barb & Plug
CO881360CM	3 x 60lb Secondary Regulator w/ Shut-Off, 5/16" Barb & Plug
CO881460CM	4 x 60lb Secondary Regulator w/ Shut-Off, 5/16" Barb & Plug



CO881062CM



CO881260CM

Taprite Secondary Regulators

SECONDARY WALL-MOUNT REGULATORS

Product Code	Description
CO881062T	60lb Secondary Regulator w/ Shut-Off & 5/16" Barbs
CO881063T	60lb Secondary Regulator w/ Shut-Off, 5/16" Barbs & Plug
CO881065T	60lb Secondary Regulator w/ Shut-Off - No Fittings



CO881062T



CO881063T

Tecflo Secondary Regulators

TECFLO SECONDARY REGULATOR

Product Code	Description
CO851005TF	60lb Secondary Regulator w/ Shut-Off - No Fittings



CO851005TF

TECFLO SECONDARY REGULATOR FITTINGS

Product Code	Description
QD100700	3/8" Stem x 3/8" Barb Quick Connect Push-In Fitting
QD300701TF	304SS 3/8" Stem x 3/8" Barb Quick Connect Push-In Fitting
QD200555	3/8" Stem Plug



QD300701TF

TECFLO REGULATOR SPACERS - Easily gang multiple secondaries together, no tools required!

Product Code	Description
CO851008	Tecflo 2.25" SS Tube Regulator Spacer
CO851012	Tecflo 4" SS Tube Regulator Spacer
CO851015	Tecflo 4.75" SS Tube Regulator Spacer
CO851018	Tecflo 5.5" SS Tube Regulator Spacer



CO851012

Metal Gas Distributors

METAL GAS DISTRIBUTORS

Product Code	Description
BB101611	1 Way Distributor w/ Shut-Off, 5/16" Barb Fitting & Plug
BB101612	2 Way Distributor w/ Shut-Offs, 5/16" Barb Fitting & Plug
BB101613	3 Way Distributor w/ Shut-Offs, 5/16" Barb Fitting & Plug
BB101614	4 Way Distributor w/ Shut-Offs, 5/16" Barb Fitting & Plug
BB101615	5 Way Distributor w/ Shut-Offs, 5/16" Barb Fitting & Plug
BB101616	6 Way Distributor w/ Shut-Offs, 5/16" Barb Fitting & Plug



BB101613

Secondary Regulator Panels

Chill-Max Secondary Regulator Panels provide an all-in-one solution to keeping your cooler installs organized and professional. Loaded with convenient, innovative features and manufactured to the highest quality standards, Chill-Max Panels will exceed your expectations.

FEATURES

- Easy to Clean, Durable Powder Coated Panel
- 304SS Beer Fittings
- 1/4", 5/16", & 3/8" FOB Outlet Options
- Tamper Resistant Regulator
- Easily Add a Regulator to Create a Ganged Assembly

STANDARD COMPONENTS

- NSF Skip Bond Jumper Line Sets
- 1/4", 5/16", & 3/8" 304SS Barbed Tailpieces
- Stainless Steel Beer Nuts
- Neoprene Washers
- Gas Fittings to Connect to Adjacent Panels
- Gas & Beverage Lines Attached

OPTIONAL ADD-ONS

- Personalize Panel with your Company Logo
- Wall Bracket Fitting Kits
- 304SS FOB Detectors
- Beer Pumps & Reversal Valves
- SS Beer Manifolds
- FOB Drain Bottle Kits

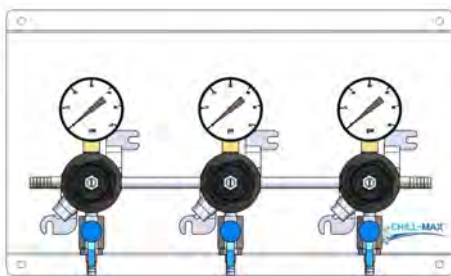

CO874003TFX

CHILL-MAX STANDARD REGULATOR PANEL

Product Code	Description
CO874001TFX	1 Pressure
CO874002TFX	2 Pressures
CO874003TFX	3 Pressures
CO874004TFX	4 Pressures

- No Tubing or Beer Fittings

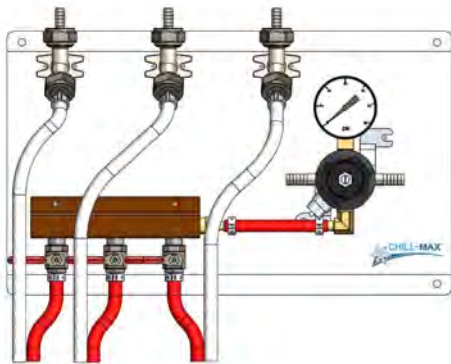

CO867013TF

CHILL-MAX GAS DISTRIBUTOR PANELS

Product Code	Description
CO867012TF	1 Pressure - 2 Products
CO867013TF	1 Pressure - 3 Products
CO867014TF	1 Pressure - 4 Products

- 6' Skip Bond Jumpers
- Tailpieces for 1/4", 5/6", & 3/8" ID Tubing
- 304SS Wall Brackets
- Gas & Beverage Lines Attached
- Gas Fittings to Connect to Adjacent Panels

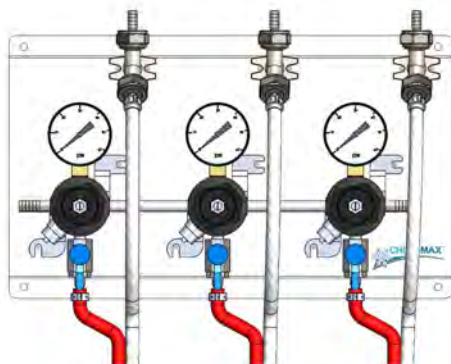

CO875003TF

CHILL-MAX DELUXE REGULATOR PANELS

Product Code	Description
CO875001TF	1 Pressure
CO875002TF	2 Pressures
CO875003TF	3 Pressures
CO875004TF	4 Pressures

- 6' Skip Bond Jumpers
- Tailpieces for 1/4", 5/6", & 3/8" ID Tubing
- 304SS Wall Brackets
- Gas & Beverage Lines Attached
- Gas Fittings to Connect to Adjacent Panels

Chill-Max Panels

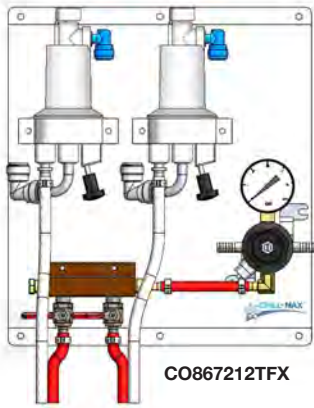

CHILL-MAX ACRYLIC FOB/GAS DISTRIBUTOR PANELS

Product Code	Description
CO867212TFX	1 Pressure / 2 Products; Tecflo Acrylic Smart FOB
CO867213TFX	1 Pressure / 3 Products; Tecflo Acrylic Smart FOB's
CO867214TFX	1 Pressure / 4 Products; Tecflo Acrylic Smart FOB's

- 6' Skip Bond Jumpers
- Gas & Beverage Lines Attached
- Tailpieces for 1/4", 5/6", & 3/8" ID Tubing
- Gas Fittings to Connect to Adjacent Panels

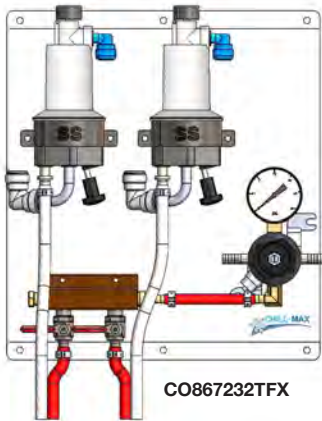

CHILL-MAX STAINLESS STEEL FOB/GAS DISTRIBUTOR PANELS

Product Code	Description
CO867232TFX	1 Pressure / 2 Products; Tecflo SS Smart FOB
CO867233TFX	1 Pressure / 3 Products; Tecflo SS Smart FOB's
CO867234TFX	1 Pressure / 4 Products; Tecflo SS Smart FOB's

- 6' Skip Bond Jumpers
- Gas & Beverage Lines Attached
- Tailpieces for 1/4", 5/6", & 3/8" ID Tubing
- Gas Fittings to Connect to Adjacent Panels

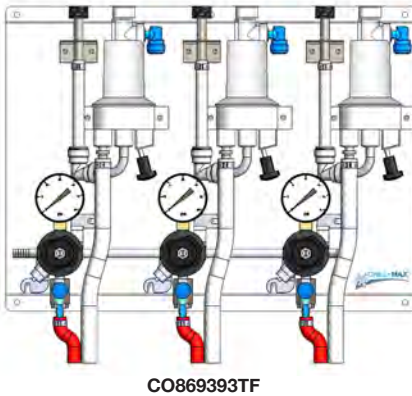

CHILL-MAX REG/ACRYLIC FOB PANELS

Product Code	Description
CO869391TF	1 Pressure / 1 Product; Tecflo Acrylic Smart FOB
CO869392TF	2 Pressure / 2 Products; Tecflo Acrylic Smart FOB's
CO869393TF	3 Pressure / 3 Products; Tecflo Acrylic Smart FOB's
CO869394TF	4 Pressure / 4 Products; Tecflo Acrylic Smart FOB's

- 6' Skip Bond Jumpers
- Gas & Beverage Lines Attached
- Tailpieces for 1/4", 5/6", & 3/8" ID Tubing
- Gas Fittings to Connect to Adjacent Panels
- 304SS Wall Brackets

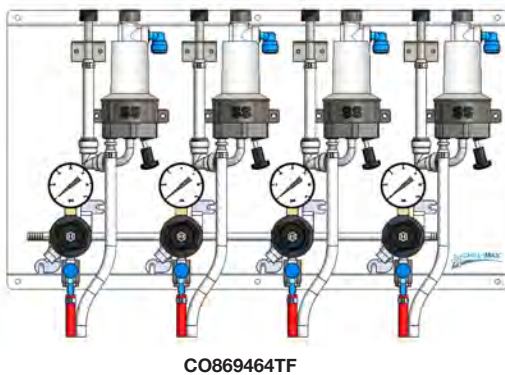

CHILL-MAX REG/STAINLESS STEEL FOB PANELS

Product Code	Description
CO869461TF	1 Pressure / 1 Product; Tecflo SS Smart FOB
CO869462TF	2 Pressure / 2 Products; Tecflo SS Smart FOB's
CO869463TF	3 Pressure / 3 Products; Tecflo SS Smart FOB's
CO869464TF	4 Pressure / 4 Products; Tecflo SS Smart FOB

- 6' Skip Bond Jumpers
- Gas & Beverage Lines Attached
- Tailpieces for 1/4", 5/6", & 3/8" ID Tubing
- Gas Fittings to Connect to Adjacent Panels
- 304SS Wall Brackets

Beer Pump Panels

CHILL-MAX REG/ACRYLIC FOB BEER PUMP PANEL

Product Code	Description
CO869251TF-RX	1 Pressure / 1 Product; Tecflo Acrylic Smart FOB
CO869253TF-RX	1 Pressure / 2 Product; Tecflo Acrylic Smart FOB's
CO869256TF	1 Pressure / 1 Product; Tecflo Acrylic Smart FOB & Reversal Valve
CO869258TF	1 Pressure / 2 Product; Tecflo Acrylic Smart FOB's & Reversal Valves

- 6' Skip Bond Jumpers
- Tailpieces for 1/4", 5/6", & 3/8" ID Tubing
- 304SS Wall Brackets
- Gas & Beverage Lines Attached
- Gas Fittings to Connect to Adjacent Panels

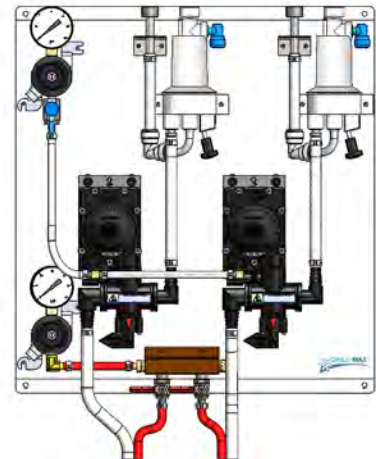

CO869258TF

CHILL-MAX REG/STAINLESS STEEL FOB BEER PUMP PANEL

Product Code	Description
CO869281TF-RX	1 Pressure / 1 Product; Tecflo SS Smart FOB
CO869283TF-RX	1 Pressure / 2 Product; Tecflo SS Smart FOB's
CO869286TF	1 Pressure / 1 Product; Tecflo SS Smart FOB & Reversal Valve
CO869288TF	1 Pressure / 2 Product; Tecflo SS Smart FOB's & Reversal Valves

- 6' Skip Bond Jumpers
- Tailpieces for 1/4", 5/6", & 3/8" ID Tubing
- 304SS Wall Brackets
- Gas & Beverage Lines Attached
- Gas Fittings to Connect to Adjacent Panels

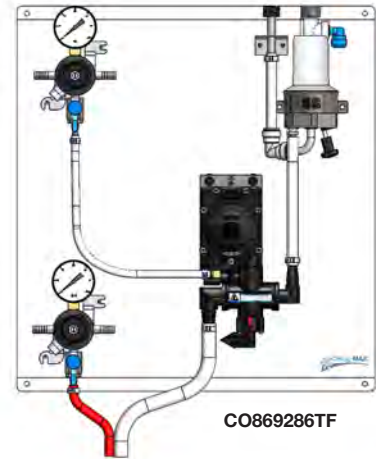

CO869286TF

Standard Panel Components

Standard Chill-Max Secondary Regulator Panels are equipped with the following fittings to ensure easy installation and adaptation:



BB101507SS



BB101508SS



BB101510SS



BB101536-SS



BB101030

Product Code	Description
BB101507SS	1/4" 304SS Tailpiece
BB101510SS	5/16" 304SS Tailpiece
BB101508SS	3/8" 304SS Tailpiece

Product Code	Description
BB101536-SS	Stainless Steel Beer Nut

Product Code	Description
BB101030	Neoprene Washer

■ Keg Couplers

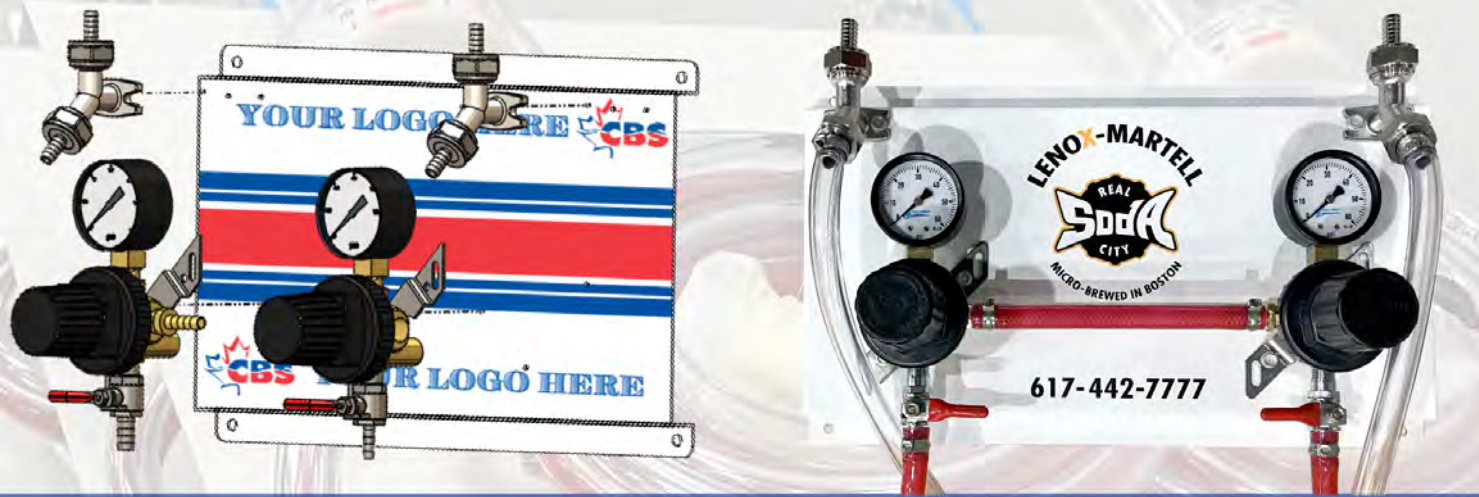

CUSTOM BRANDED REGULATOR PANELS

Custom printed with UV-cured ink on a durable powder coated surface, CBS & Chill-Max panels offer an attractive, functional way to showcase your brand and keep your business top of mind.

QUICK-DISCONNECT FITTINGS | SKIP BOND JUMPER LINES | TAMPER RESISTANT REGULATOR | PUSH-IN FITTINGS

Keg Couplers



BB100968SS

"D" SYSTEM

Product Code	Description
BB100968SS	Chill-Max "D" System 304SS Keg Coupler w/ 304SS Body & Probe
BB100050-SS	Perlick Lo-Boy "D" System Coupler w/ 304SS Probe



BB100978SS

"S" SYSTEM

Product Code	Description
BB100978SS	Chill-Max "S" System 304SS Keg Coupler w/ 304SS Body & Probe
BB100051-SS	Perlick Lo-Boy "S" System Coupler w/ 304SS Probe



BB101001B-TS

EUROPEAN COUPLERS

Product Code	Description
BB101002B-TS	TOF "A" System Keg Coupler w/ 304SS Probe
BB101000B-TS	TOF "G" System Keg Coupler w/ 304SS Probe
BB101001B-TS	TOF "U" System Keg Coupler w/ 304SS Probe

ACRYLIC FOB DETECTORS

Product Code	Description
MP551050	Tecflo Classic FOB Detector with 2-3/8" Barb Fittings
MP551050-KIT	Tecflo Classic FOB with Kit
MP551039	DFC Wall Mt. FOB Detector with 3/8" OD Inlet & Outlet
MP551041	DFC Wall Mt. FOB Detector with Beer Thread Inlet & Outlet
MP551049	Tecflo SMART FOB Detector with 2-3/8" Barb Fittings



MP551039



MP551041



MP551050-KIT



MP551049



MP551069

STAINLESS STEEL FOB DETECTORS

Product Code	Description
MP551069	Tecflo 304SS SMART FOB Detector with 2-3/8" Barb Fittings

FOB Accessories & Fittings



MP551158

FOB DRAIN BOTTLES & TUBING

Product Code	Description
MP551158	FOB Drain Bottle and Wall Bracket
MP551149	FOB Drain Bottle Kit - 6 Product
MP551150	FOB Drain Bottle Kit - 10 Product
BT385250	1/4" ID x 3/8" OD Clear Vinyl FOB Drain Tubing
BT385175	1/8" ID x 3/16" OD Clear Vinyl FOB Drain Tubing



MP551150

FOB FITTINGS

Product Code	Description
SF087100	1/8" Barb "Y" Fitting for FOB Drain Tubing
QD200561	3/8" Stem x 3/16" Reducer - Straight
QD100697	3/8" OD Stem x 5/16" Barb Fitting - Straight
QD100700	3/8" OD Stem x 3/8" Barb Fitting - Straight
QD100764	3/8" OD Stem x 5/16" Barb Fitting - Elbow
QD100765	3/8" OD Stem x 3/8" Barb Fitting - Elbow
QD300701TF	304SS 3/8" OD Stem x 3/8" Barb Push-In Fitting -Straight
QD375375	304SS 3/8" OD x 3/8" OD Push-In Fitting -Elbow



QD100700



QD100697



QD100764



SF087100

Flow Control & Gas Blenders



BB101663



BB101665

SS BEER MANIFOLD

Product Code	Description
BB101662	2 Outlet w/ Beer Threads & 1 x 3/8" Barb Inlet
BB101663	3 Outlet w/ Beer Threads & 1 x 3/8" Barb Inlet
BB101664	4 Outlet w/ Beer Threads & 1 x 3/8" Barb Inlet

FLOW CONTROL

Product Code	Description
MP555022	Flojet G56 Beer Pump
MP555022-RV	Flojet G56 Flow Reversal Valve
MP551060	In-Line Flow Control 3/8" OD x 5/16" OD
MP551064	304SS In-Line Flow Control 5/16" SS OD x 5/16" SS OD
MP551066	304SS In-Line Flow Control 3/8" OD x 3/8" OD



MP555022-RV



MP555022



MP551060



MP551064

Gas Blenders



McDantim Gas Blenders are an efficient, cost-saving solution for maintaining carbonation without producing excess foam. Dial in the perfect level by selecting the gas blend that suits the style of beer being poured.

MCDANTIM TRUMIX® GAS BLENDERS

Product Code	Description
BB80100-60-40	Trumix Single Gas Blender: 60%CO2-40%N2
BB80100-70-30	Trumix Single Gas Blender: 70%CO2-30%N2
BB802-2575-5050	Trumix Double Gas Blender: 25%CO2-75%N2+50%CO2-50%N2
BB802-2575-6040	Trumix Double Gas Blender: 25%CO2-75%N2+60%CO2-40%N2
BB802-2575-7030	Trumix Double Gas Blender: 25%CO2-75%N2+70%CO2-30%N2



BB80100-60-40



BB80200-25/75-60/40

MCDANTIM GAS BLENDER COMPONENTS

Product Code	Description
BB801013	In-Line Check Valve "T"- 1/4" x 1/4" x 1/4"
BB801042	In-Line Check Valve "T"- 3/8" x 3/8" x 3/8"



BB801013



BB801042

MCDANTIM LEAK DETECTORS

Product Code	Description
BB803239	Single In-Line Leak Indicator (MV039)
BB803240	Double In-Line Leak Indicator (MV035)



BB803240



Keg Racks

ADJUSTABLE KEG STORAGE RACKS - 17" DEEP

Product Code	Description
BB709542	68"H x 42"W x 17"D; 4 Kegs
BB709548	68"H x 48"W x 17"D; 4 Kegs
BB709560	68"H x 60"W x 17"D; 6 Kegs
BB709580	68"H x 80"W x 17"D; 8 Kegs
BB709593	68"H x 93"W x 17"D; 10 Kegs

DOUBLE DEEP ADJUSTABLE KEG RACK - 34" DEEP

Product Code	Description
BB709842	68"H x 42"W x 34"D; 8 Kegs
BB709848	68"H x 48"W x 34"D; 8 Kegs
BB709860	68"H x 60"W x 34"D; 12 Kegs
BB709880	68"H x 80"W x 34"D; 16 Kegs
BB709893	68"H x 93"W x 34"D; 20 Kegs

OPTIONAL ADJUSTABLE BACK STOPS

Product Code	Description
BB709142	42"W Back Stop for BB709542 Rack
BB709148	48"W Back Stop for BB709548 Rack
BB709160	60"W Back Stop for BB709560 Rack
BB709180	80"W Back Stop for BB709580 Rack
BB709193	93"W Back Stop for BB709593 Rack



Keg Fridge Organization

Offering safe storage and transport solutions for Kegs in a Walk-in Cooler. Use the Keg Storage Stacker or Keg Series Stacker to increase the storage capacity in a Walk-in Cooler and use the Keg Dolly for safe transport of full Kegs.

KEG STORAGE STACKER

Product Code	Description
BB702600	Keg Organizer - Keg Stack & Store 2 Kegs
BB702590	Keg Organizer - Keg Stack & Tap 2 20L Slim Kegs

KEG SERIES STACKER

Product Code	Description
BB702603	Keg Stacker - Keg Stack & Tap 2 Kegs
BB702593	Keg Stacker - Keg Stack & Tap 2 20L Slim Kegs

KEG DOLLY

Product Code	Description
BB702604	Keg Dolly - Transport 1 Half Barrel (58L) Keg



BB702590

BB702593



BB702600

BB702603



BB702604

■ Chill–Max Glycol Power Packs

Chill–Max Air Cooled Glycol Power Packs

1/3 HP COMPACT GLYCOL POWER PACK – 2560 BTU'S

Product Code	Pumps	Volts	Dimensions	Weight	Plug	Outlet
BB991050	1	115V-15 Amp Circuit	16 1/2" x 20" x 20"	63lbs	5-15P	Remote
• Digital Thermostat		• * 4.5 Gallon Bath	• Vertical Pump	• NSF 51 Rotocast Polyethylene Bath		
BB991051	1	115V-15 Amp Circuit	16 1/2" x 20" x 20 1/2"	72lbs	5-15P	Remote
• Digital Thermostat		• 4.5 Gallon Bath	• Dumper Coupling	• 1/3 HP 115V Motor	• NSF 51 Rotocast Polyethylene Bath	
			• Rotary Vane Pump			



BB991050



BB991051

1/3 HP GLYCOL POWER PACKS – 3282 BTU'S

Product Code	Pumps	Volts	Dimensions	Weight	Plug	Outlet
BB991060	1	115V-15 Amp Circuit	20 1/2" x 27 1/2" x 23"	120lbs	5-15P	Remote
BB991065	2	115V-20 Amp Circuit	26 1/2" x 27 1/2" x 23"	115lbs	5-15P	Remote
• Digital Thermostat		• 17 Gallon Bath	• Dumper Coupling	• 1/3 HP 115V Motor	• NSF 51 Rotocast Polyethylene Bath	
			• Rotary Vane Pump			



BB991060

1/2 HP COMPACT GLYCOL POWER PACK – 3370 BTU'S

Product Code	Pumps	Volts	Dimensions	Weight	Plug	Outlet
BB991057	1	115V-15 Amp Circuit	11 7/8" x 20 x 20"	63lbs	5-15P	Remote
• Digital Thermostat		• 4.5 Gallon Bath	• Vertical Pump	• NSF 51 Rotocast Polyethylene Bath		
BB991058	1	115V-15 Amp Circuit	11 7/8" x 20 x 20"	72lbs	5-15P	Remote
• Digital Thermostat		• 4.5 Gallon Bath	• Dumper Coupling	• 1/3 HP 115V Motor	• NSF 51 Rotocast Polyethylene Bath	
			• Rotary Vane Pump			



BB991057



BB991058

1/2 HP GLYCOL POWER PACKS – 4080 BTU'S

Product Code	Pumps	Volts	Dimensions	Weight	Plug	Outlet
BB991070	1	115V-15 Amp Circuit	20 1/2" x 27 1/2" x 23"	135lbs	5-15P	Remote
BB991075	2	115V-25 Amp Circuit	26 1/2" x 27 1/2" x 23"	145lbs	5-15P	Remote
• Digital Thermostat		• 17 Gallon Bath	• Dumper Coupling	• 1/3 HP 115V Motor	• NSF 51 Rotocast Polyethylene Bath	
			• Rotary Vane Pump			



BB991070

3/4 HP GLYCOL POWER PACKS – 6138 BTU'S

Product Code	Pumps	Volts	Dimensions	Weight	Plug	Outlet
BB991080	1	115V-20 Amp Circuit	26 1/2" x 18" x 30"	149lbs	5-15P	Remote
BB991085	2	115V-25 Amp Circuit	32" x 28" x 30"	159lbs	5-20P	Remote
BB991090	3	115V-30 Amp Circuit	26 1/2" x 27 1/2" x 29"	169lbs	5-20P	Remote
• Digital Thermostat		• 17 Gallon Bath	• Dumper Coupling	• 1/3 HP 115V Motor	• NSF 51 Rotocast Polyethylene Bath	
			• Rotary Vane Pump			



BB991080



BB991105

1 HP GLYCOL POWER PACKS - 8202 BTU'S

Product Code	Pumps	Volts	Dimensions	Weight	Plug	Outlet
BB991100	2	220V-20 Amp Circuit	24" x 28" x 30"	145lbs	5-20P	Remote
BB991105	3	220V-20 Amp Circuit	35" x 25" x 30"	155lbs	5-20P	Remote

- Digital Thermostat
- Dumper Coupling
- 1/3 HP 115/230V Motor
- 17 Gallon Bath
- Rotary Van Pump
- NSF 51 Rotocast Polyethylene Bath



BB991110

1-1/2 HP GLYCOL POWER PACKS - 11200 BTU'S

Product Code	Pumps	Volts	Dimensions	Weight	Plug	Outlet
BB991110	2	220V-25 Amp Circuit	24" x 28" x 30"	145lbs	5-20P	Remote
BB991115	3	220V-30 Amp Circuit	35" x 25" x 36"	155lbs	5-20P	Remote

- Digital Thermostat
- Dumper Coupling
- 1/3 HP 115/230V Motor
- 17 Gallon Bath
- Rotary Vane Pump
- NSF 51 Rotocast Polyethylene Bath

100% PROPYLENE GLYCOL USP

Product Code	Description
BB990099	100% Propylene Glycol USP - 4 Litre Jug / 1 Gallon
BB990102	100% Propylene Glycol USP - 18.9 Litre / 5 Gallons



BB990099



BB990102



BB708224

POWER PACK RACKS

Product Code	Description
BB708224	24"H x 36"W x 24"D; 1200lb Capacity; Wt. - 30lbs
BB708248	48"H x 36"W x 24"D; 1200lb Capacity; Wt. - 38lbs



BB708248

CHILL-MAX POWER PACK REPLACEMENT PARTS

Product Code	Description
MP551740	1/3 HP 115V Motor - 1725 RPM
MP551742	1/3 HP 115/230V Dual Voltage Motor - 1725 RPM
MP000448	Dumper Coupling Kit
MP000599	Foam Pump Jacket - Grey
MP000585	75 GHP Brass Rotary Vane Pump
MP000587	105 GHP Brass Rotary Vane Pump
BB991205	Digital Thermostat & Probe Assembly for CM Glycol PP
BB991201	Relay for CM Glycol Power Pack Digital Thermostat
BB990025-CPA	Vertical Pump Assembly for BB991050/57 Compact Power Packs



MP551740



MP000448



MP000585



BB991205



BB990025-CPA

Chill-Max Glycol Power Packs

PUMP ASSEMBLIES

Product Code	Description
BB98983-75	75 GPH Brass Rotary Vane Pump Assembly
BB98984-105	105 GPH Brass Rotary Vane Pump Assembly



BB98983-75

PUMP & MOTOR ASSEMBLIES

Product Code	Description
BB989860	75 GPH Brass Rotary Vane Pump & 115V Motor Assembly
BB989861	105 GPH Brass Rotary Pump & 115V Motor Assembly
BB988075	75 GPH Brass Rotary Vane Pump & 115/230V Dual Voltage Motor Assembly



BB989860

TAPES

Product Code	Description
MP100700	Insulation Tape - 2" Wide x 30'
MP100704	Insulation Tape - 2" Wide x 48'
MP100737	Insulation Tape - 7" Wide x 48'
MP100810	Vinyl Electrical Tape - 2" Wide x 60' - 1 Roll
MP100820	Vinyl Electrical Tape - 2" Wide - 1 Sleeve (4 Rolls)
MP100825	Vinyl Electrical Tape - 2" Wide - 1 Case (80 Rolls)
MP100862	3mm Foil Tape - 2" Wide x 180'
MP100883	2mm Foil Tape - 3" Wide x 150'
MP100887	2mm Filament Moisture Strap 2" Wide x 180'



MP100820



MP100810



MP100700



MP100737

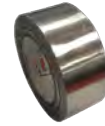

MP100862



MP100887

GLYCOL CONNECTOR

Product Code	3/4" Wall
BT020200	2 Line Glycol Connector
BT020400	4 Line Glycol Connector



BT020200



BT020400

TUBE INSULATION

Product Code	3/8" Wall
BT000010	5/8" ID x 3/8" Wall Thickness
BT000012	7/8" ID x 3/8" Wall Thickness
1/2" Wall	
BT000085	1/2" ID x 1/2" Wall Thickness
BT000090	3/4" ID x 1/2" Wall Thickness
BT000118	1-1/8" ID x 1/2" Wall Thickness
BT000138	1-3/8" ID x 1/2" Wall Thickness
BT000158	1-5/8" ID x 1/2" Wall Thickness
BT000178	1-7/8" ID x 1/2" Wall Thickness
BT000218	2-1/8" ID x 1/2" Wall Thickness
3/4" Wall	
BT007078	7/8" ID x 3/4" Wall Thickness
BT007118	1-1/8" ID x 3/4" Wall Thickness
BT007138	1-3/8" ID x 3/4" Wall Thickness
BT007158	1-5/8" ID x 3/4" Wall Thickness
BT007178	1-7/8" ID x 3/4" Wall Thickness
BT007218	2-1/8" ID x 3/4" Wall Thickness



BT000090



BT007118



COLD KIT COMPONENTS

Product Code	Description
SF600375	SS 3/8" OD Tube Compression x 3/8" Barb
BB700218	Square Brass Cold Block - Fits Standard 7/8" Beer Shank

TRUNKLINE MOUNTING BRACKET

Product Code	Description
MP000742	Trunkline Mounting Bracket - Black

Glycol System Installation Kits



COMPLETE GLYCOL SYSTEM KITS

ID	4 Lines	6 Lines	10 Lines	12 Lines
1/4"	BB92280C	BB92290C	BB94250C	BB95250C
5/16"	BB92284C	BB92312C	BB94312C	BB95312C
3/8"	BB92288C	BB92375C	BB94375C	BB95375C



ADD-ON GLYCOL SYSTEM KITS

ID	4 Lines	6 Lines	10 Lines	12 Lines
1/4"	BB92283M	BB92297M	BB94263M	BB95263M
5/16"	BB92286M	BB92335M	BB94323M	BB95323M
3/8"	BB92289M	BB92382M	BB94383M	BB95383M

FLOW RESTRICTORS

Product Code	Beer Lines	Description
BT785250	6	Restrictor Kit - 1/4" ID Tubing
BT785260	6	Restrictor Kit - 5/16" ID Tubing
BT785270	6	Restrictor Kit - 3/8" ID Tubing
Kit Includes:		
		<ul style="list-style-type: none"> • 3 x 24 Segment Restrictor Elements • 24 x 304SS Stepless Clamps • 6 x 1' Lengths of 1/4" ID Barrier Tubing • 6 x 304SS 1/4" Splicers
BB101580-250	N/A	Restrictor Element - 12 Segment

Flow Restrictors

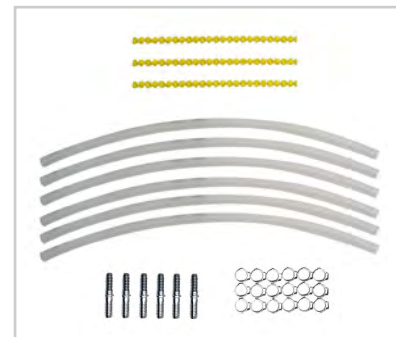

DRAUGHT BEER TOWERS

SS Brewery Pipe & Flange Series

Bridge

3" DIA. BRIDGE WITH CHILL-MAX™ COOLING CARTRIDGE - FAUCETS 3" OC

Product Code	Taps	Finish	Cooling	Drip Tray
BB102770-08SSCK	8	Polished SS	Glycol	24"
BB102770-10SSCK	10	Polished SS	Glycol	30"
BB102770-12SSCK	12	Polished SS	Glycol	36"

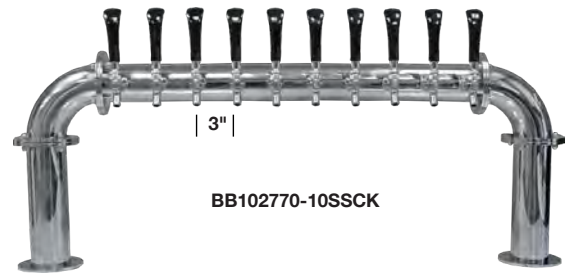

* Air cooled versions of this tower style are also available.

* Powder coat finishes available.

* Contact sales

Rail

3" DIA. RAIL WITH CHILL-MAX™ COOLING CARTRIDGE - FAUCETS 3" OC

Product Code	Taps	Finish	Cooling	Drip Tray
BB102765-06SS	6	Polished SS	Air	20"
BB102765-08SS	8	Polished SS	Air	24"
BB102765-10SS	10	Polished SS	Air	30"
BB102765-12SS	12	Polished SS	Air	36"



* Glycol cooled versions of this tower style are also available.

* Powder coat & Brushed Stainless Steel finishes available.

Drip Trays

3" DIA. BRIDGE & RAIL DRIP TRAYS WITH DRAIN

Product Code	# Faucets	Dimensions	Glass Rinser
BB701320	6T	20"W x 7"D	X
BB702420	6T	20"W x 7"D	✓
BB701324	8T	24"W x 7"D	X
BB702424	8T	24"W x 7"D	✓
BB701330	10T	30"W x 7"D	X
BB702430	10T	30"W x 7"D	✓
BB701336	12T	36"W x 7"D	X
BB702436	12T	36"W x 7"D	✓



BB701320



BB702424

Condor "T"

4" Dia. SS Brewery Pipe & Flange

4" DIA. CONDOR WITH CHILL-MAX™ COOLING CARTRIDGE - FAUCETS 3" OC

Finish:		Candy Copper	Candy Gold	Matte Black	Brushed SS	Polished SS	
Taps	Cooling	Product Code	Product Code	Product Code	Product Code	Product Code	Drip Tray
4T	Glycol	BB101810-CC-04GC	BB101810-CG-04GC	BB101810-MB-04GC	BB101810-04GC	BB101812-04GC	20"
6T	Glycol	BB101810-CC-06GC	BB101810-CG-06GC	BB101810-MB-06GC	BB101810-06GC	BB101812-06GC	30"
8T	Glycol	BB101810-CC-08GC	BB101810-CG-08GC	BB101810-MB-08GC	BB101810-08GC	BB101812-08GC	33"
10T	Glycol	BB101810-CC-10GC	BB101810-CG-10GC	BB101810-MB-10GC	BB101810-10GC	BB101812-10GC	39"

* Air cooled versions of this tower style are also available. * 100's of powder coat finishes available. * Contact sales

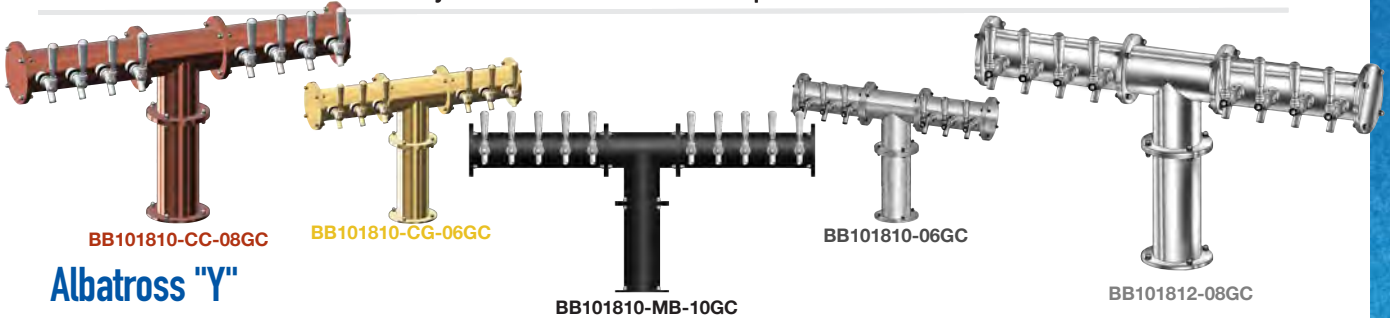

Albatross "Y"

4" DIA. ALBATROSS WITH CHILL-MAX™ COOLING CARTRIDGE - FAUCETS 3" OC

Finish:		Candy Copper	Candy Gold	Matte Black	Brushed SS	Polished SS	
Taps	Cooling	Product Code	Product Code	Product Code	Product Code	Product Code	Drip Tray
6T	Glycol	BB101820-CC-06GC	BB101820-CG-06GC	BB101820-MB-06GC	BB101819-06GC	BB101820-06GC	2 x 12"
8T	Glycol	BB101820-CC-08GC	BB101820-CG-08GC	BB101820-MB-08GC	BB101819-08GC	BB101820-08GC	2 x 12"
10T	Glycol	BB101820-CC-10GC	BB101820-CG-10GC	BB101820-MB-10GC	BB101819-10GC	BB101820-10GC	2 x 16"
12T	Glycol	BB101820-CC-12GC	BB101820-CG-12GC	BB101820-MB-12GC	BB101819-12GC	BB101820-12GC	2 x 20"

* Air cooled versions of this tower style are also available. * 100's of powder coat finishes available. * Contact sales

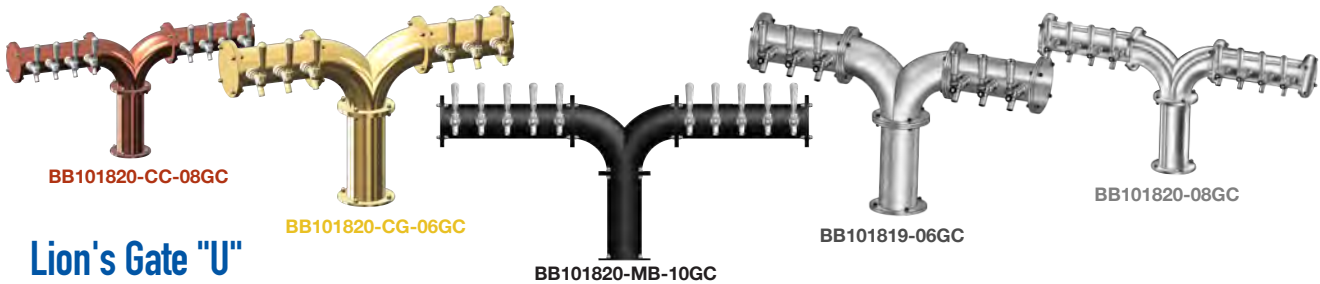

Lion's Gate "U"

4" DIA. LION'S GATE WITH CHILL-MAX™ COOLING CARTRIDGE - FAUCETS 3" OC

Finish:		Candy Copper	Candy Gold	Matte Black	Brushed SS	Polished SS	
Taps	Cooling	Product Code	Product Code	Product Code	Product Code	Product Code	Drip Tray
6T	Glycol	BB101830-CC-06GC	BB101830-CG-06GC	BB101830-MB-06GC	BB101829-06GC	BB101830-06GC	20"
8T	Glycol	BB101830-CC-08GC	BB101830-CG-08GC	BB101830-MB-08GC	BB101829-08GC	BB101830-08GC	24"
10T	Glycol	BB101830-CC-10GC	BB101830-CG-10GC	BB101830-MB-10GC	BB101829-10GC	BB101830-10GC	30"
12T	Glycol	BB101830-CC-12GC	BB101830-CG-12GC	BB101830-MB-12GC	BB101829-12GC	BB101830-12GC	36"

* Air cooled versions of this tower style are also available. * 100's of powder coat finishes available. * Contact sales

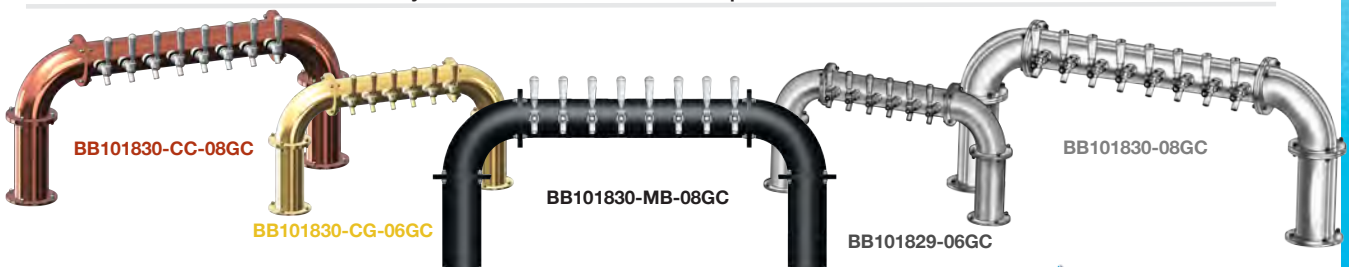

4" Dia. SS Brewery Pipe & Flange

4" DIA. LION'S GATE WITH CHILL-MAX™ COOLING CARTRIDGE - FAUCETS 4" OC

Finish:		Candy Copper	Candy Gold	Matte Black	Brushed SS	Polished SS	
Taps	Cooling	Product Code	Product Code	Product Code	Product Code	Product Code	Drip Tray
6T	Glycol	BB102630-CC-06GC	BB102630-CG-06GC	BB102630-MB-06GC	BB102629-06GC	BB102630-06GC	24"
8T	Glycol	BB102630-CC-08GC	BB102630-CG-08GC	BB102630-MB-08GC	BB102629-08GC	BB102630-08GC	33"
10T	Glycol	BB102630-CC-10GC	BB102630-CG-10GC	BB102630-MB-10GC	BB102629-10GC	BB102630-10GC	39"
12T	Glycol	BB102630-CC-12GC	BB102630-CG-12GC	BB102630-MB-12GC	BB102629-12GC	BB102630-12GC	51"

* Air cooled versions of this tower style are also available. * 100's of powder coat finishes available. * Contact sales

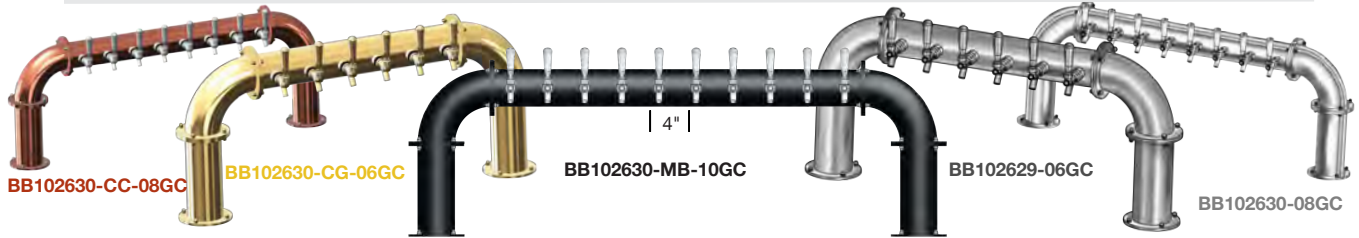

Lion's Gate Wall Mt.

4" DIA. LION'S GATE WALL MT. WITH CHILL-MAX™ COOLING CARTRIDGE - FAUCETS 3" OC

Finish:		Candy Copper	Candy Gold	Matte Black	Brushed SS	Polished SS	
Taps	Cooling	Product Code	Product Code	Product Code	Product Code	Product Code	Drip Tray
6T	Glycol	BB101845-CC-06GC	BB101845-CG-06GC	BB101845-MB-06GC	BB101844-06GC	BB101845-06GC	20"
8T	Glycol	BB101845-CC-08GC	BB101845-CG-08GC	BB101845-MB-08GC	BB101844-08GC	BB101845-08GC	24"
10T	Glycol	BB101845-CC-10GC	BB101845-CG-10GC	BB101845-MB-10GC	BB101844-10GC	BB101845-10GC	30"
12T	Glycol	BB101845-CC-12GC	BB101845-CG-12GC	BB101845-MB-12GC	BB101844-12GC	BB101845-12GC	36"

* Air cooled versions of this tower style are also available. * 100's of powder coat finishes available. * Contact sales

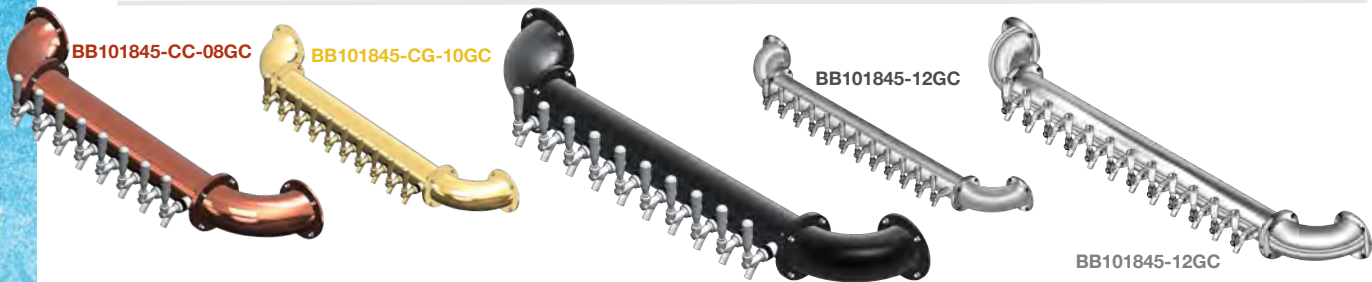

4" DIA. LION'S GATE WALL MT. WITH CHILL-MAX™ COOLING CARTRIDGE - FAUCETS 4" OC

Finish:		Candy Copper	Candy Gold	Matte Black	Brushed SS	Polished SS	
Taps	Cooling	Product Code	Product Code	Product Code	Product Code	Product Code	Drip Tray
6T	Glycol	BB102645-CC-06GC	BB102645-CG-06GC	BB102645-MB-06GC	BB102640-06GC	BB102645-06GC	24"
8T	Glycol	BB102645-CC-08GC	BB102645-CG-08GC	BB102645-MB-08GC	BB102640-08GC	BB102645-08GC	33"
10T	Glycol	BB102645-CC-10GC	BB102645-CG-10GC	BB102645-MB-10GC	BB102640-10GC	BB102645-10GC	39"
12T	Glycol	BB102645-CC-12GC	BB102645-CG-12GC	BB102645-MB-12GC	BB102640-12GC	BB102645-12GC	51"

* Air cooled versions of this tower style are also available. * 100's of powder coat finishes available. * Contact sales

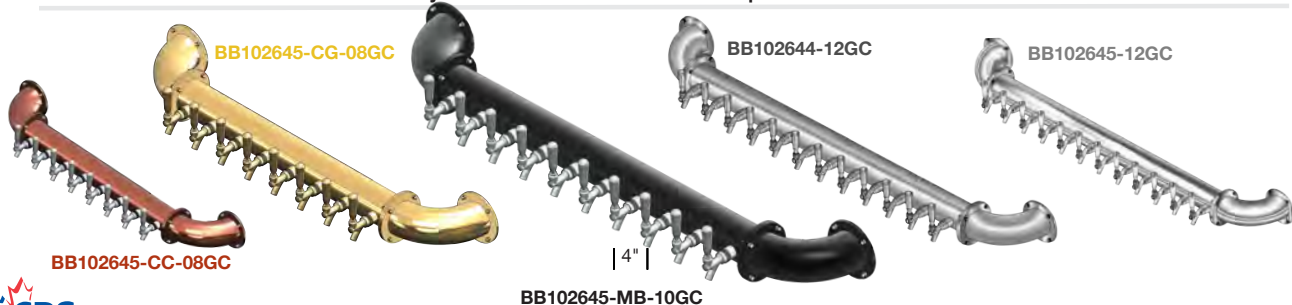

Eagle™T

6" DIA, EAGLE "T" WITH CHILL-MAX™ COOLING CARTRIDGE - FAUCETS 4" OC

Product Code	Taps	Finish	Cooling	Drip Tray
BB102655-06SSCK	6T	Polished SS	Glycol	2 x 12"
BB102655-08SSCK	8T	Polished SS	Glycol	2 x 16"
BB102655-10SSCK	10T	Polished SS	Glycol	2 x 20"
BB102655-12SSCK	12T	Polished SS	Glycol	2 x 24"

- * Air cooled versions of this tower style are also available.
- * Powder coat & Brushed Stainless Steel finishes available. Contact sales

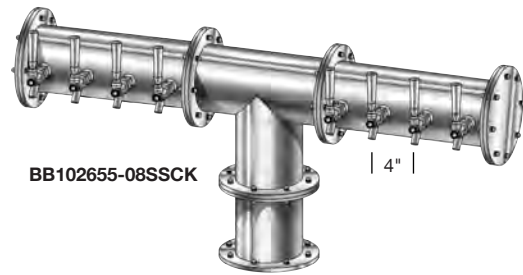

BB102655-08SSCK

* We design custom drip trays to suit any style of tower. Contact sales for additional details.

Double Service Eagle

6" DIA. DBL. SERVE EAGLE WITH CHILL-MAX™ COOLING CARTRIDGE - FAUCETS 4" OC

Product Code	Taps	Finish	Cooling	Drip Tray
BB102665-12SSCK	12T	Polished SS	Glycol	30"
BB102665-16SSCK	16T	Polished SS	Glycol	33"
BB102665-20SSCK	20T	Polished SS	Glycol	45"
BB102665-24SSCK	24T	Polished SS	Glycol	51"

- * Air cooled versions of this tower style are also available.
- * Powder coat & Brushed Stainless Steel finishes available. Contact sales

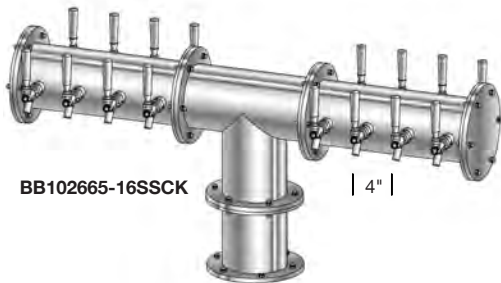

BB102665-16SSCK

Eagle Tower Drip Trays



BB701424

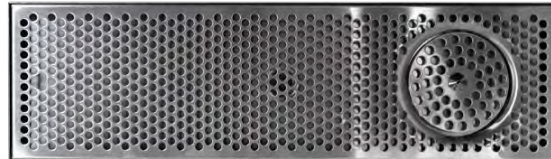

BB702424

EAGLE DRIP TRAYS

Product Code	Faucets	Dimensions	Glass Rinser	Drain
BB701312	6T	2ea 12"W x 7"D	X	✓
BB702412	6T	2ea 12"W x 7"D	✓	✓
BB701316	8T	2ea 16"W x 7"D	X	✓
BB702416	8T	2ea 16"W x 7"D	✓	✓
BB701320	10T	2ea 20"W x 7"D	X	✓
BB702420	10T	2ea 20"W x 7"D	✓	✓
BB701324	12T	2ea 24"W x 7"D	X	✓
BB702424	12T	2ea 24"W x 7"D	✓	✓

DOUBLE SERVICE EAGLE DRIP TRAYS

Product Code	Faucets	Dimensions	Glass Rinser	Drain
BB701312	12T	4 ea 12"W x 7"D	X	✓
BB702412	12T	4ea 12"W x 7"D	✓	✓
BB701316	16T	4ea 16"W x 7"D	X	✓
BB702416	16T	4ea 16"W x 7"D	✓	✓
BB701320	20T	4ea 20"W x 7"D	X	✓
BB702420	20T	4ea 20"W x 7"D	✓	✓
BB701324	24T	4ea 24"W x 7"D	X	✓
BB702424	24T	4ea 24"W x 7"D	✓	✓

Golden Gate

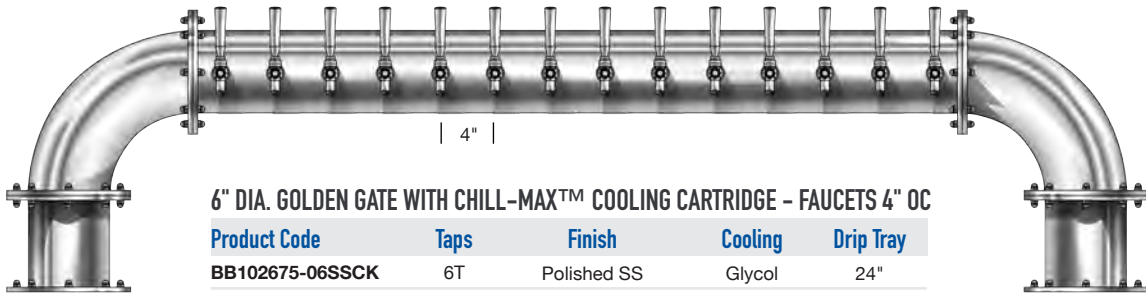

6" DIA. GOLDEN GATE WITH CHILL-MAX™ COOLING CARTRIDGE - FAUCETS 4" OC

Product Code	Taps	Finish	Cooling	Drip Tray
BB102675-06SSCK	6T	Polished SS	Glycol	24"
BB102675-08SSCK	8T	Polished SS	Glycol	33"
BB102675-10SSCK	10T	Polished SS	Glycol	39"
BB102675-12SSCK	12T	Polished SS	Glycol	51"
BB102675-14SSCK	14T	Polished SS	Glycol	2 x 30"
BB102675-16SSCK	16T	Polished SS	Glycol	2 x 33"

* Powder coat & Brushed Stainless Steel finishes available. Contact sales.

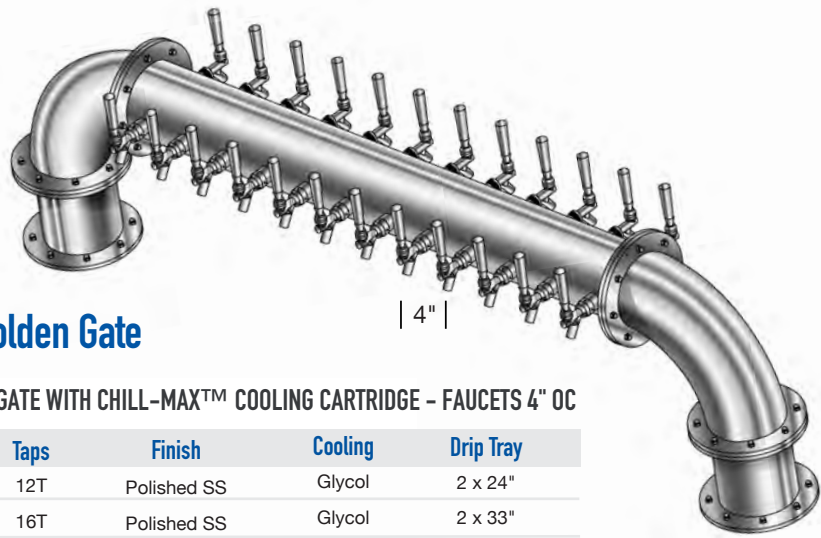

Double Service Golden Gate

6" DIA. DBL SERVE GOLDEN GATE WITH CHILL-MAX™ COOLING CARTRIDGE - FAUCETS 4" OC

Product Code	Taps	Finish	Cooling	Drip Tray
BB102685-12SSCK	12T	Polished SS	Glycol	2 x 24"
BB102685-16SSCK	16T	Polished SS	Glycol	2 x 33"
BB102685-20SSCK	20T	Polished SS	Glycol	2 x 39"
BB102685-24SSCK	24T	Polished SS	Glycol	2 x 51"

* Powder coat & Brushed Stainless Steel finishes available. Contact sales.

Golden Gate Drip Trays

GOLDEN GATE DRIP TRAYS

Product Code	Faucets	Dimensions	Glass Rinsers	Drain
BB701324	6T	24"W x 7"D	X	✓
BB702424	6T	24"W x 7"D	✓	✓
BB701330	8T	30"W x 7"D	X	✓
BB702430	8T	30"W x 7"D	✓	✓
BB701339	10T	39"W x 7"D	X	✓
BB702439	10T	39"W x 7"D	✓	✓
BB701351	12T	51"W x 7"D	X	✓
BB702451	12T	51"W x 7"D	✓	✓
BB701330	14T	2ea 30"W x 7"D	X	✓
BB702430	14T	2ea 30"W x 7"D	✓	✓
BB701333	16T	2ea 33"W x 7"D	X	✓
BB701433	16T	2ea 33"W x 7"D	✓	✓



BB701339

DOUBLE SERVICE GOLDEN GATE DRIP TRAYS

Product Code	Faucets	Dimensions	Glass Rinsers	Drain
BB701324	12T	2ea 24"W x 7"D	X	✓
BB702424	12T	2ea 24"W x 7"D	✓	✓
BB701330	16T	2ea 30"W x 7"D	X	✓
BB702430	16T	2ea 30"W x 7"D	✓	✓
BB701339	20T	2ea 39"W x 7"D	X	✓
BB702439	20T	2ea 39"W x 7"D	✓	✓
BB701351	24T	2ea 51"W x 7"D	X	✓
BB702451	24T	2ea 51"W x 7"D	✓	✓



Welcome to Design Central

Specializing in bespoke design, CBS & Chill-Max deliver on the promise of tailoring draught tower design to meet the needs of our customers, every time!

25+ years of experience creating innovative, high-quality products for the beverage dispense industry is what sets us apart. Our teams are driven to make a difference and deliver your vision on time and within budget.

Our experienced team of creative designers and talented craftsmen are ready to work with you through our 4D process - Dream, Design, Develop and Deliver - to turn your vision into reality.

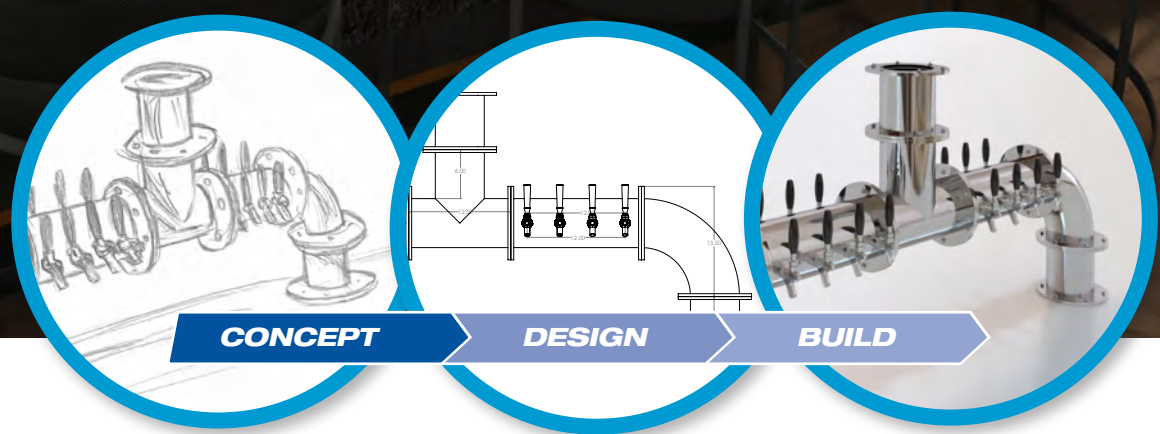

From Concept to Completion

Create the “WOW” factor at the bar by choosing from a variety of draught tower options, or Dream, Design and Develop a unique, one of kind custom draught tower. Our custom solutions creative team will work side by side with you to Deliver a beautifully crafted tower that exceeds expectations.

Along the path we will establish the look you’re after and incorporate the use of graphic design software to produce digital mockups of that look.

Not sure what draught tower shape, size and color is right for the space? No worries, our industry experienced, creative solutions team is here to support you throughout the journey.

Once we land on the perfect design, CAD files will be created showing the tower layout and all dimensions. From here we tweak the design with any edits and establish production timelines and cost. Next step is your approval and the scheduling of production and delivery.



Custom Layouts

Are you working with a non-traditional or unique space that requires a bespoke tower design? We are well established and experienced working with one's imagination and the dream of creating something truly special. Your vision may be able to be built from standard modular pipe tower components and if not, we build custom parts to achieve the desired outcome. Anything is possible, you can hang a tower from the ceiling, turn a corner or design around architectural features. Let us get creative!





Suits Any Style

The draught tower is an integral part of the overall design. Not only do we want the draught tower to be the focal point of the bar, it needs to fit the interior design theme of the overall space. From Old World Pub to Minimal Modernist, Industrial to Eclectic, our team is here to help create a draught tower that aligns with your vision.





Stainless Steel



Gold



Copper



Black



Red

Custom Finishes to Enhance the Space

Brushed, polished, matte, satin powder-coated, hammered...

Draught towers are available in many materials and finishes. Create a unique atmosphere with an Industrial style tower or keep things modern with sleek Stainless Steel.

The only limit is your imagination! Standard finishes include Polished or Brushed Stainless Steel. Powder Coating is available in Matte, Satin, Translucent, Metallic, Vivid or Pastel.

You do not have to pick just one, why not mix and match? Choose a two-tone finish to make a statement. Have a specific finish or color in mind? Ask us about our ability to match a specific finish.

From configuration to finish, we will work with you to craft a draught tower that suits your style and needs. Are you ready to bring your vision to life?

Choose Your Finish:

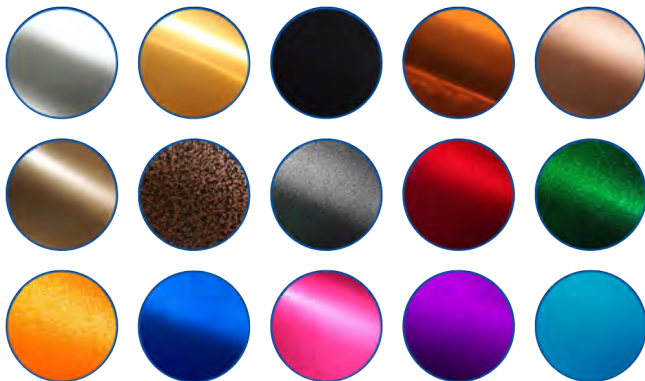

Modular Industrial Pipe

Metro

METRO "T" WITH CHILL-MAX™ COOLING CARTRIDGE



BB102700-12PVDCK

Product Code	Taps	Finish	Cooling	Length
BB102700-4PVDCK	4T	PVD-BRS	Glycol	18"
BB102700-4SSCK	4T	Polished SS	Glycol	18"
BB102700-6PVDCK	6T	PVD-BRS	Glycol	24"
BB102700-6SSCK	6T	Polished SS	Glycol	24"
BB102700-8PVDCK	8T	PVD-BRS	Glycol	30"
BB102700-8SSCK	8T	Polished SS	Glycol	30"
BB102700-10PVDCK	10T	PVD-BRS	Glycol	30"
BB102700-10SSCK	10T	Polished SS	Glycol	30"
BB102700-12SSCK	12T	Polished SS	Glycol	36"

* Air cooled versions of this tower style are also available.

* Powder coat & Brushed Stainless Steel finishes available. Contact sales

METRO "H" WITH CHILL-MAX™ COOLING CARTRIDGE - FAUCETS 3" OC

Product Code	Taps	Finish	Cooling	Drip Tray
BB102710-08SSCK	8	Polished SS	Glycol	28"
BB102710-10SSCK	10	Polished SS	Glycol	34"
BB102710-12SSCK	12	Polished SS	Glycol	40"
BB102710-14SSCK	14	Polished SS	Glycol	46"
BB102710-16SSCK	16	Polished SS	Glycol	52"

* Air cooled versions of this tower style are also available.

* Powder coat & Brushed Stainless Steel finishes available. Contact sales



BB102710-10SSCK

Metro Drip Trays

METRO "T" DRIP TRAYS WITH DRAIN



BB702163



BB716163

Product Code	Faucets	Dimensions	Finish	Glass Rinsers
BB701125	4T	18"L x 9"W x 7/8"H	SS	X
BB702125	4T	18"L x 9"W x 7/8"H	SS	✓
BB716125	4T	18"L x 9"W x 7/8"H	PVD	X
BB701163	6T	24"L x 8"W x 7/8"H	SS	X
BB702163	6T	24"L x 8"W x 7/8"H	SS	✓
BB716163	6T	24"L x 8"W x 7/8"H	PVD	X
BB701170	8-10T	30"L x 8"W x 7/8"H	SS	X
BB702170	8-10T	30"L x 8"W x 7/8"H	SS	✓
BB716170	8-10T	30"L x 8"W x 7/8"H	PVD	X
BB701186	12T	36"L x 8"W x 7/8"H	SS	X
BB702186	12T	36"L x 8"W x 7/8"H	SS	✓

METRO "H" TOWER DRIP TRAYS WITH DRAIN

Product Code	Faucets	Dimensions	Finish	Glass Rinsers
BB701628	8	28"L x 8"W x 7/8"H	SS	X
BB702628	8	28"L x 8"W x 7/8"H	SS	✓
BB701634	10	34"L x 8"W x 7/8"H	SS	X
BB702634	10	34"L x 8"W x 7/8"H	SS	✓
BB701640	12	40"L x 8"W x 7/8"H	SS	X
BB702640	12	40"L x 8"W x 7/8"H	SS	✓
BB701646	14	46"L x 8"W x 7/8"H	SS	X
BB702646	14	46"L x 8"W x 7/8"H	SS	✓
BB701652	16	52"L x 8"W x 7/8"H	SS	X



BB701628



BB702634

■ Pass Thru Towers

Pass Thru

4" PASS THRU AIR - FAUCET 3" OC

Product Code	Taps	Finish	Cooling	Length	Drip Tray
BB102479-06	6	Brushed SS	Air	31"	20"
BB102479-08	8	Brushed SS	Air	37"	24"
BB102479-10	10	Brushed SS	Air	43"	30"
BB102479-12	12	Brushed SS	Air	49"	36"

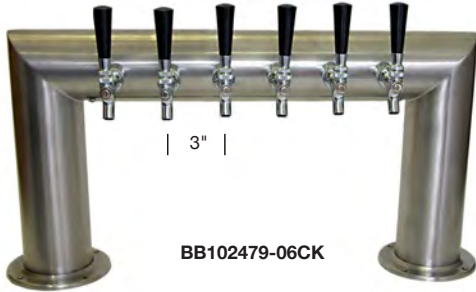

PASS THRU WITH CHILL-MAX™ COOLING CARTRIDGE - FAUCETS 3" OC

Product Code	Taps	Finish	Cooling	Length	Drip Tray
BB102479-06CK	6	Brushed SS	Glycol	31"	20"
BB102479-08CK	8	Brushed SS	Gycol	37"	24"
BB102479-10CK	10	Brushed SS	Glycol	43"	30"
BB102479-12CK	12	Brushed SS	Glycol	49"	36"
BB102479-14CK	14	Brushed SS	Glycol	55"	45"

* Powder coat finishes available * Contact sales

Beverage System Key Parts & Components

Learn more about the key components that make up a state-of-the-art CBS & Chill-Max beverage dispense system.

- 1 Chill-Max Beverage Dispensing Tower, pg. 24-50**
Each tower is equipped with a Chill-Max Insert for optimal cooling & dispense.
- 2 Drip Tray, pg. 32; 51; 55**
Drip trays can be equipped with a glass rinsers to ensure proper pours.
- 3 Trunkline, pg. 20-21**
Insulated trunklines provide constant contact between cooling and beverage lines.
- 4 Secondary Regulator Panel w/ FOBs, pg. 6-8**
Ensure your kegs are pouring properly & minimize waste with Chill-Max Regulator Panels.
- 5 Power Pack, pg. 14-18**
Keep your lines cool with a properly vented glycol air-cooled power pack.
- 6 Gas Dispense System, pg. 11**
Creates optimal gas blend to pour your beverage properly.
- 7 CO2 Monitor, pg. 11**
Keep your employees safe by monitoring for the presence of CO2.



DRAUGHT TOWER COOLING CARTRIDGE

FOAM FREE TOWER COOLING SOLUTION

CBS & Chill-Max Draught Towers are equipped with an innovative cooling cartridge that keeps beverage lines cool and foam free.

Simplify draught tower installation & maintenance with a custom cartridge.

CHILL-MAX COOLING CARTRIDGE FEATURES

- 304SS Shanks, Tubes, & Faucets
- Air or Glycol Cooling
- Cold Core Technology
- Non-Toxic Recyclable Foam Clam Shells
- Hardened Aluminum Cold Blocks
- Available with 3" - 7" Faucet Centers
- Wall-Mount, Ceiling-Mount, & Counter-Mount Applications
- Custom Sizes & Layouts Available on Request

Contact our Sales Team for a Quote!

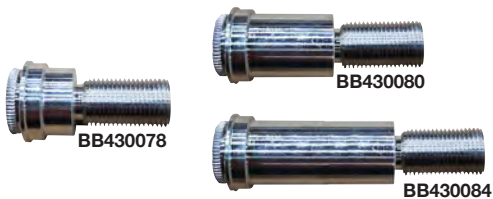

CHILL-MAX™ COOLING CARTRIDGE 304SS SCREW-IN SHANKS

Product Code	Description
BB430078	304SS 2" Screw-In Shank for maximum 7/16" wall thickness
BB430080	304SS 2-3/4" Screw-In Shank maximum 1-3/16" wall thickness
BB430084	304SS 3-3/4" Screw-In Shank maximum 2-3/16" wall thickness

CHILL-MAX™ WALL-MOUNT COOLING CARTRIDGES

No. Faucets	Faucet Centers	Cooling	Shank Length	Restriction	Tube Exit
2-12	3"	Glycol	2", 2 3/4", or 3 3/4"	15lbs	Center Back
2-10	4"	Glycol	2", 2 3/4", or 3 3/4"	15lbs	Center Back
2-8	5"	Glycol	2", 2 3/4", or 3 3/4"	15lbs	Center Back
2-7	6"	Glycol	2", 2 3/4", or 3 3/4"	15lbs	Center Back
2-6	7"	Glycol	2", 2 3/4", or 3 3/4"	15lbs	Center Back

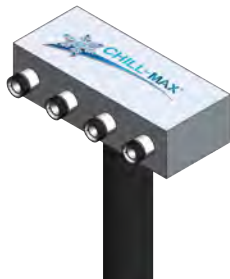

CHILL-MAX™ "T" TOWER COOLING CARTRIDGES

No. Faucets	Faucet Centers	Cooling	Shank Length	Restriction	Tube Exit
2-12	3"	Glycol	2", 2 3/4", or 3 3/4"	15lbs	Center Bottom
2-10	4"	Glycol	2", 2 3/4", or 3 3/4"	15lbs	Center Bottom
2-8	5"	Glycol	2", 2 3/4", or 3 3/4"	15lbs	Center Bottom

CHILL-MAX™ PIPE TOWER COOLING CARTRIDGES (3", 4", 5", 6", or 8" Diameter)

No. Faucets	Faucet Centers	Cooling	Shank Length	Restriction	Tube Exit
2-12	3"	Glycol	2", 2 3/4", or 3 3/4"	15lbs	Side
2-10	4"	Glycol	2", 2 3/4", or 3 3/4"	15lbs	Side
2-8	5"	Glycol	2", 2 3/4", or 3 3/4"	15lbs	Side
2-7	6"	Glycol	2", 2 3/4", or 3 3/4"	15lbs	Side
2-6	7"	Glycol	2", 2 3/4", or 3 3/4"	15lbs	Side

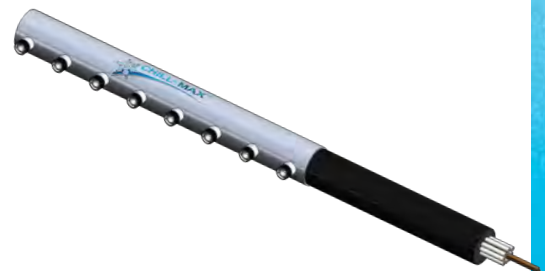

"T" Towers

3" DIA. "T" TOWER WITH CHILL-MAX™ COOLING CARTRIDGE - FAUCETS 3" OC

Product Code	Taps	Finish	Cooling	Length	Drip Tray
BB102010-03CK	3	Brushed SS	Glycol	12"	12"
BB102010-04CK	4	Brushed SS	Glycol	12"	12"
BB102010-05CK	5	Brushed SS	Glycol	16"	16"
BB102010-06CK	6	Brushed SS	Glycol	18"	20"

* Air cooled versions of this tower & powder coat finishes available. Contact sales



BB102010-06CK

4" DIA. "T" TOWER AIR - FAUCETS

3" OC Product Code	Tap	Finish	Cooling	Length	Drip Tray
BB102020-04	4	Brushed SS	Air	12"	12"
BB102020-05	5	Brushed SS	Air	16"	16"
BB102020-06	6	Brushed SS	Air	20"	20"



BB102020-04CK

4" DIA. "T" TOWER WITH CHILL-MAX™ COOLING CARTRIDGE - FAUCETS 3" OC

Product Code	Taps	Finish	Cooling	Length	Drip Tray
BB102020-04CK	4	Brushed SS	Glycol	12"	12"
BB102020-05CK	5	Brushed SS	Glycol	16"	16"
BB102020-06CK	6	Brushed SS	Glycol	20"	20"
BB102020-08CK	8	Brushed SS	Glycol	24"	24"

* Powder coat finishes available. Contact sales



BB102030-08CK

Double Pedestal

DOUBLE PEDESTAL 4" WITH CHILL-MAX™ COOLING CARTRIDGE - FAUCETS 3" OC

Product Code	Taps	Finish	Cooling	Length	Drip Tray
BB102030-08CK	8	Brushed SS	Glycol	27"	24"
BB102030-10CK	10	Brushed SS	Glycol	33"	33"
BB102030-12CK	12	Brushed SS	Glycol	39"	39"
BB102030-16CK	16	Brushed SS	Glycol	51"	51"

* Powder coat finishes available. Contact sales

EASY IDENTIFICATION
Quickly Identify the Secondary Regulator or Keg Coupler Associated with a Specific Beer Line.

FLEXIBLE APPLICATION
Numbered Decal can be Placed on a Regulator Panel, Gas or Beer Line, or Walk-in Cooler Wall.

DURABLE MATERIALS
Laminated to Protect the Print and Offer Many Years of Clear Visibility.

Messy Keg Fridge? Get Organized!

Custom Branded Identification Decals

Mushroom



BB101386-CK

MUSHROOM AIR

Product Code	Taps	Finish	Cooling	Cut-Out	Drip Tray
BB101384C	4	Brushed SS	Air	7.5"	19"
BB101385C	5	Brushed SS	Air	7.5"	19"
BB101386C	6	Brushed SS	Air	7.5"	24"

MUSHROOM WITH CHILL-MAX™ COOLING CARTRIDGE

Product Code	Taps	Finish	Cooling	Cut-Out	Drip Tray
BB101384-CK	4	Brushed SS	Glycol	7.5"	19"
BB101385-CK	5	Brushed SS	Glycol	7.5"	19"
BB101386-CK	6	Brushed SS	Glycol	7.5"	24"

* Powder coat finishes available. Contact sales



BB101374-CK

MINI MUSHROOM AIR

Product Code	Taps	Finish	Cooling	Cut-Out	Drip Tray
BB101374C	4	Brushed SS	Air	6"	18"
BB101375C	5	Brushed SS	Air	6"	18"

MINI MUSHROOM WITH CHILL-MAX™ COOLING CARTRIDGE

Product Code	Taps	Finish	Cooling	Cut-Out	Drip Tray
BB101374-CK	4	Brushed SS	Glycol	6"	18"
BB101375-CK	5	Brushed SS	Glycol	6"	18"

* Powder coat finishes available. Contact sales

Space Mizer

SPACE MIZER WITH CHILL-MAX™ COOLING CARTRIDGE - FAUCETS 3" OC

Product Code	Taps	Finish	Cooling	Length
BB103614-04CK	4	Brushed SS	Glycol	14"
BB103620-05CK	5	Brushed SS	Glycol	20"
BB103620-06CK	6	Brushed SS	Glycol	20"
BB103626-08CK	8	Brushed SS	Glycol	26"
BB103632-10CK	10	Brushed SS	Glycol	32"
BB103638-12CK	12	Brushed SS	Glycol	38"

* Air cooled versions of this tower style are also available. Contact sales



BB103614-04CK



BB103775-08CK

Kronos

KRONOS WITH CHILL-MAX™ COOLING CARTRIDGE

Product Code	Taps	Finish	Cooling	Length
BB103775-08CK	8	Brushed SS	Glycol	24"
BB103775-10CK	10	Brushed SS	Glycol	30"
BB103775-12CK	12	Brushed SS	Glycol	36"

* Air cooled versions of this tower are also available

* Powder coat finishes available. Contact sales

KRONOS WITH GLASS RINSER & CHILL-MAX™ COOLING CARTRIDGE

Product Code	Taps	Finish	Cooling	Length
BB103780-08CK	8	Brushed SS	Glycol	24"
BB103780-10CK	10	Brushed SS	Glycol	30"
BB103780-12CK	12	Brushed SS	Glycol	36"

* Air cooled versions of this tower are also available

* Powder coat finishes available. Contact sales



BB103780-10CK

Column Towers

Column

3" DIA. COLUMN - AIR

Product Code	Taps	Faucet Style	Finish	Tubing	Drip Tray
BB101402	1	304SS	Polished SS	Vinyl	10"
BB101406	2	304SS	Polished SS	Vinyl	10"
BB101419	3	304SS	Polished SS	Vinyl	10"
BB102402	1	304SS	Matte Black	Vinyl	10"
BB102406	2	304SS	Matte Black	Vinyl	10"
BB102419	3	304SS	Matte Black	Vinyl	10"

- * Glycol cooled versions of this tower style are also available.
- * Powder coat finishes available. Contact sales



BB101402



BB102402

3" DIA. COLUMN - AIR WITH NSF FLEXIBLE TOTAL BARRIER TUBING

Product Code	Taps	Faucet Style	Finish	Tubing	Drip Tray
BB125402C	1	304SS	Polished SS	Total Barrier	10"
BB125406C	2	304SS	Polished SS	Total Barrier	10"
BB125419C	3	304SS	Polished SS	Total Barrier	10"
BB126402	1	304SS	Matte Black	Total Barrier	10"
BB126406	2	304SS	Matte Black	Total Barrier	10"
BB126419	3	304SS	Matte Black	Total Barrier	10"

- * Glycol cooled versions of this tower style are also available.
- * Powder coat finishes available. Contact sales



BB101406



BB102406

3" SINGLE METAL COLUMN ADDITIONS

Product Code	Taps
BB101397-1	Add 1 Tap to a 2 Tap 3" Tower
BB101397-2	Add 2 Taps to a 1 Tap 3" Tower
BB101398	Add 1 Tap to a 1 Tap 3" Tower



BB101397-1



BB101397-2



BB101398



BB101420



BB101422-C

4" DIA. COLUMN - AIR

Product Code	Taps	Faucet Style	Finish	Tubing	Drip Tray
BB101412C	3	304SS	Polished SS	Vinyl	12"
BB101412SS	3	304SS	Brushed SS	Vinyl	12"
BB101422C	4	304SS	Polished SS	Vinyl	14"
BB101422SS	4	304SS	Brushed SS	Vinyl	14"

- * Glycol cooled versions of this tower style are also available.
- * Powder coat finishes available. Contact sales



BB1021A-CK



BB102141A-CK

Mongoose

MONGOOSE

Product Code	Taps	Finish	Cooling	Drip Tray
BB102140A-CK	1	Chrome	Glycol	10"
BB102141A-CK	1	Gold	Glycol	10"
BB102150A-CK	2	Chrome	Glycol	10"
BB102151A-CK	2	Gold	Glycol	10"
BB102160A-CK	3	Chrome	Glycol	12"
BB102161A-CK	3	Gold	Glycol	12"
BB102170A-CK	4	Chrome	Glycol	15"
BB102171A-CK	4	Gold	Glycol	15"

* Air cooled versions of this tower style are also available. Contact sales



BB102170A-CK

MEDIUM MONGOOSE

Product Code	Taps	Finish	Cooling	Drip Tray
BB102290A-CK	1	Chrome	Glycol	10"
BB102295A-CK	2	Chrome	Glycol	10"
BB102290A	1	Chrome	Air	10"
BB102295A	2	Chrome	Air	10"



BB102290A



BB102295A-CK



8 9/16"

BB102280A

MINI MONGOOSE

Product Code	Taps	Finish	Cooling	Drip Tray
BB102280A-CK	1	Chrome	Glycol	10"
BB102280A	1	Chrome	Air	10"

Cobra

COBRA AIR

Product Code	Taps	Finish	Cooling	Drip Tray
BB101452A	2	Chrome	Air	10"
BB101453A	3	Chrome	Air	12"
BB101454A	4	Chrome	Air	15"

COBRA GLYCOL

Product Code	Taps	Finish	Cooling	Drip Tray
BB101452A-CK	2	Chrome	Glycol	10"
BB101453A-CK	3	Chrome	Glycol	12"
BB101454A-CK	4	Chrome	Glycol	15"

* Cobra towers are also available in a Gold finish. Lead-times vary, contact sales for details.



BB101454A-CK

■ Drip Trays

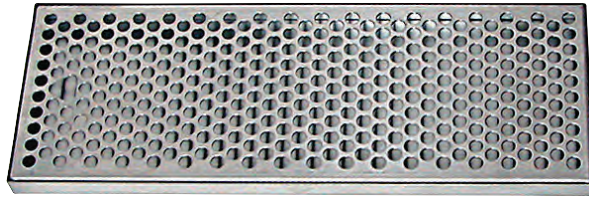

BB700812



BB701912



BB701320



BB716316

Surface Mount Drip Trays

STAINLESS STEEL - 5 3/8" WIDE - NO DRAIN

Product Code	L	D	H	Drain
BB700802	10 3/8"	5 3/8"	3/4"	X
BB700808	12"	5 3/8"	3/4"	X
BB700812	15"	5 3/8"	3/4"	X
BB700817	20"	5 3/8"	3/4"	X
BB700822	24"	5 3/8"	3/4"	X
BB700832	30 1/4"	5 3/8"	3/4"	X

STAINLESS STEEL - 5 3/8" WIDE WITH DRAIN

Product Code	L	D	H	Drain
BB701902	10 3/8"	5 3/8"	3/4"	✓
BB701908	12"	5 3/8"	3/4"	✓
BB701912	15"	5 3/8"	3/4"	✓
BB701917	20"	5 3/8"	3/4"	✓
BB701922	24"	5 3/8"	3/4"	✓
BB701947	39"	5 3/8"	3/4"	✓
BB701952	45 1/4"	5 3/8"	3/4"	✓
BB701962	51"	5 3/8"	3/4"	✓

STAINLESS STEEL - 7" WIDE WITH DRAIN

Product Code	L	D	H	Drain
BB701312	12"	7"	7/8"	✓
BB701316	16"	7"	7/8"	✓
BB701320	20"	7"	7/8"	✓
BB701324	24"	7"	7/8"	✓
BB701330	30"	7"	7/8"	✓
BB791333	33"	7"	7/8"	✓
BB701336	36"	7"	7/8"	✓
BB701339	39"	7"	7/8"	✓
BB701345	45"	7"	7/8"	✓
BB701351	51"	7"	7/8"	✓

PVD INSERT WITH SS TRAY - 7" WIDE WITH DRAIN

Product Code	L	D	H	Drain
BB716312	12"	7"	7/8"	✓
BB716316	16"	7"	7/8"	✓
BB716320	20"	7"	7/8"	✓
BB716324	24"	7"	7/8"	✓
BB716330	30"	7"	7/8"	✓
BB716336	36"	7"	7/8"	✓

STAINLESS STEEL TRAYS - WITH GLASS RINSER

Product Code	L	D	H	Glass Rinsers
BB702408	8"	8"	7/8"	Center
BB702412	12"	7"	7/8"	Center
BB702416	16"	7"	7/8"	Side
BB702420	20"	7"	7/8"	Side
BB702424	24"	7"	7/8"	Side
BB702430	30"	7"	7/8"	Side
BB702436	36"	7"	7/8"	Side
BB702439	39"	7"	7/8"	Side
BB702445	45"	7"	7/8"	Side
BB702451	51"	7"	7/8"	Side



BB702408



BB702416

STAINLESS STEEL TRAYS WITH CUT OUT AND GLASS RINSER

Product Code	L	D	H	Cut Out	Glass Rinsers
BB702110	15"	7 1/2"	7/8"	4 1/2"	Side
BB702125	18"	9"	7/8"	6 1/4"	Side
BB702160	22"	11"	7/8"	7 1/4"	Side
BB702163	24"	8"	7/8"	6"	Side
BB702170	30"	8"	7/8"	6"	Side
BB702180	34"	8"	7/8"	6"	Side
BB702186	36"	8"	7/8"	6"	Side



BB702163

GLASS RINSER ASSEMBLIES

Product Code	Description
BB101174	Heavy Duty Spray Assembly (Black Plate)
BB101175	Heavy Duty Spray Assembly (Stainless Steel Plate)
BB101178-PLS	Metal Spray Assembly (Plastic Circle)
BB101179	Standard Spray Assembly (Plastic Star)



BB101178-PLS



BB101179



BB101174



BB101175

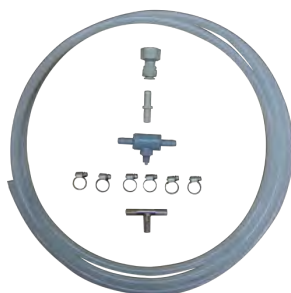

BB702002

DRIP TRAY CONNECTION KITS

Product Code	Description
BB701999	Drip Tray Drain Connector Kit
BB702002	Spray Drip Tray Connector Kit
BB702004-CMP	Chill-Max Pro Spray Drip Tray Connector Kit
BB702102-30	30 PSI Spray Drip Tray Install Kit
MP555018	Flojet Water Regulator - Preset at 30 PSI - 3/8" Barb



MP555018



BB701999

Drip Trays



BB701125

STAINLESS STEEL TRAYS WITH CUT-OUT - NO DRAIN

Product Code	L	D	H	Cut Out	Drain
BB701005	15"	7 1/2"	7/8"	4 1/2"	X
BB701020	18"	9"	7/8"	6 1/4"	X

STAINLESS STEEL TRAYS WITH CUT-OUT - WITH DRAIN

Product Code	L	D	H	Cut Out	Drain
BB701110	15"	7 1/2"	7/8"	4 1/2"	✓
BB701125	18"	9"	7/8"	6 1/4"	✓
BB701135	19"	9"	7/8"	6 1/4"	✓
BB701150	19 3/4"	10"	7/8"	8 1/4"	✓
BB701165	24"	11"	7/8"	7 1/2"	✓



BB716150

PVD INSERT W/ SS TRAY & CUT-OUT - WITH DRAIN

Product Code	L	D	H	Cut Out	Drain
BB716208	14"	8"	7/8"	6"	✓
BB716125	18"	9"	7/8"	6 1/4"	✓
BB716150	19 3/4"	10"	7/8"	8 1/4"	✓
BB716165	24"	11"	7/8"	7 1/2"	✓
BB716163	24"	8"	7/8"	6"	✓
BB716170	30"	8"	7/8"	6"	✓
BB716135	19"	9"	7/8"	6 1/4"	✓



BB702628

STAINLESS STEEL TRAYS WITH CORNER CUT-OUTS

Product Code	L	D	H	Glass Rinsers
BB701628	28"	8"	7/8"	X
BB702628	28"	8"	7/8"	✓ - Center
BB701634	34"	8"	7/8"	X
BB702634	34"	8"	7/8"	✓ - Center
BB701640	40"	8"	7/8"	X
BB702640	40"	8"	7/8"	✓ - Center
BB701646	46"	8"	7/8"	X
BB702646	46"	8"	7/8"	✓ - Center
BB701652	52"	8"	7/8"	X
BB702652	52"	8"	7/8"	✓ - Center



BB701634

Wall Mount Dispensers

STAINLESS STEEL WALL MOUNT DRIP TRAY WITH GLASS RINSER

Product Code	L	D	H	Holes	Centers
BB700115-04	16"	8"	17"	4	4"
BB700115-06	24"	8"	17"	6	4"
BB700115-08	32"	8"	17"	8	4"
BB700115-10	40"	8"	17"	10	4"
BB700115-12	48"	8"	17"	12	4"

* Faucets, handles & shanks sold separately.



BB700115-06

STAINLESS STEEL WALL MOUNT GROWLER FILLER WITH GLASS RINSER

Product Code	L	D	H	Holes	Centers
BB700138-03	18"	8"	22"	3	6"
BB700138-04	24"	8"	22"	4	6"
BB700138-05	30"	8"	22"	5	6"
BB700138-06	36"	8"	22"	6	6"
BB700138-07	42"	8"	22"	7	6"
BB700138-08	48"	8"	22"	8	6"

* Faucets, handles & shanks sold separately.



BB700138-05



BB700056-8

Wall Mount Drip Trays

STAINLESS STEEL WALL MOUNTED DRIP TRAYS - FAUCETS 3" OC

Product Code	L	D	H	Holes	Drain
BB700053-3	12"	6 3/8"	14"	3	Yes
BB700053-4	12"	6 3/8"	14"	4	Yes
BB700055-4	16"	6 3/8"	14"	4	Yes
BB700055-5	16"	6 3/8"	14"	5	Yes
BB700056-6	24"	6 3/8"	14"	6	Yes
BB700056-8	24"	6 3/8"	14"	8	Yes
BB700057-10	30"	6 3/8"	14"	10	Yes
BB700058-12	36"	6 3/8"	14"	12	Yes
BB700059-16	48"	6 3/8"	14"	16	Yes

304SS WALL SHANK ASSEMBLIES

Product Code	Description
BB101295-03SS	3 1/8" 304SS Shank Assembly w/ 1/4" Bore
BB101295-04SS	4 1/8" 304SS Shank Assembly w/ 1/4" Bore
BB101295-05SS	5 1/8" 304SS Shank Assembly w/ 1/4" Bore
BB101295-06SS	6 1/8" 304SS Shank Assembly w/ 1/4" Bore
BB101295-08SS	8 1/8" 304SS Shank Assembly w/ 1/4" Bore
BB101295-10SS	10 1/8" 304SS Shank Assembly w/ 1/4" Bore
BB101295-12SS	12 1/8" 304SS Shank Assembly w/ 1/4" Bore



BB101295-04SS



BB101295-06SS

■ CHILL-MAX™ Tower Cartridges

Chill-Max Glycol Cooled Tower Cartridges

CHILL-MAX 3" DIA. COLUMN "T" TOWER - FAUCETS 3" OC

Product Code	Description
CC3033TD-CLD	3 Tap, 3" Center, Bottom Tube Exit, Glycol Cooled
CC3043TD-CLD	4 Tap, 3" Center, Bottom Tube Exit, Glycol Cooled
CC3053TD-CLD	5 Tap, 3" Center, Bottom Tube Exit, Glycol Cooled
CC3063TD-CLD	6 Tap, 3" Center, Bottom Tube Exit, Glycol Cooled
CC3083TD-CLD	8 Tap, 3" Center, Bottom Tube Exit, Glycol Cooled

CHILL-MAX 4" DIA. COLUMN "T" TOWER - FAUCETS 3" OC

Product Code	Description
CC3044TD-CLD	4 Tap, 3" Center, Bottom Tube Exit, Glycol Cooled
CC3054TD-CLD	5 Tap, 3" Center, Bottom Tube Exit, Glycol Cooled
CC3064TD-CLD	6 Tap, 3" Center, Bottom Tube Exit, Glycol Cooled
CC3084TD-CLD	8 Tap, 3" Center, Bottom Tube Exit, Glycol Cooled

CHILL-MAX 4" DIA. PIPE TOWER - FAUCETS 4" OC

Product Code	Description
CC4034PS-CLD	3 Tap, 4" Center, Side Tube Exit, Glycol Cooled
CC3044PS-CLD	4 Tap, 4" Center, Side Tube Exit, Glycol Cooled
CC4064PS-CLD	6 Tap, 4" Center, Side Tube Exit, Glycol Cooled
CC4084PS-CLD	8 Tap, 4" Center, Side Tube Exit, Glycol Cooled
CC4104PS-CLD	10 Tap, 4" Center, Side Tube Exit, Glycol Cooled
CC4124PS-CLD	12 Tap, 4" Center, Side Tube Exit, Glycol Cooled

CHILL-MAX WALL MOUNT TOWER - FAUCETS 3" OC

Product Code	Description
CC3030WB-CLD	3 Tap, 3" Center, Center Back Exit, Glycol Cooled
CC3040WB-CLD	4 Tap, 3" Center, Center Back Exit, Glycol Cooled
CC3050WB-CLD	5 Tap, 3" Center, Center Back Exit, Glycol Cooled
CC3060WB-CLD	6 Tap, 3" Center, Center Back Exit, Glycol Cooled
CC3070WB-CLD	7 Tap, 3" Center, Center Back Exit, Glycol Cooled
CC3080WB-CLD	8 Tap, 3" Center, Center Back Exit, Glycol Cooled
CC3100WB-CLD	10 Tap, 3" Center, Center Back Exit, Glycol Cooled
CC3120WB-CLD	12 Tap, 3" Center, Center Back Exit, Glycol Cooled

CHILL-MAX WALL MOUNT TOWER - FAUCETS 4" OC

Product Code	Description
CC4030WB-CLD	3 Tap, 4" Center, Center Back Exit, Glycol Cooled
CC4040WB-CLD	4 Tap, 4" Center, Center Back Exit, Glycol Cooled
CC4050WB-CLD	5 Tap, 4" Center, Center Back Exit, Glycol Cooled
CC4060WB-CLD	6 Tap, 4" Center, Center Back Exit, Glycol Cooled
CC4070WB-CLD	7 Tap, 4" Center, Center Back Exit, Glycol Cooled
CC4080WB-CLD	8 Tap, 4" Center, Center Back Exit, Glycol Cooled
CC4100WB-CLD	10 Tap, 4" Center, Center Back Exit, Glycol Cooled
CC4120WB-CLD	12 Tap, 4" Center, Center Back Exit, Glycol Cooled

Chill-Max Tower Cartridges are available in numerous shapes, sizes and configurations. Our modular design concept along with the use of 3D printing expands the possibilities. Contact sales for more details.



CC3083TD-CLD



CC4064PS-CLD



CC4030WB-CLD

Chill-Max Wall Mount Tower Cartridges include 2" long 304SS Screw-In Shanks. For wall thicknesses exceeding 7/16" step up to our 2-3/4" or 3-3/4" long shanks...see page 27 for more details.



BB101212-SS

Faucets

PVD COATED 304SS DOMESTIC FAUCET

Product Code	Description
BB090216	Chill-Max 304SS/PVD-BRS Faucet with Stainless Steel Lever



BB090216



BB101214-SS

304SS DOMESTIC FAUCETS

Product Code	Description
BB090246	Chill-Max 304SS Faucet
BB101212-SS	Perlick 304SS Free Flow Faucet
BB101214-SS	Perlick 304SS Flow Control Faucet



BB090246



BB101254-G

STAINLESS STEEL STOUT FAUCETS

Product Code	Description
BB090689	Chill-Max Polished J 304SS Stout Faucet
BB101254	Polished 303SS Stout Faucet
BB101254-G	Gold Plated 303SS Stout Faucet



BB090689



BB090613

STAINLESS STEEL SPECIALTY FAUCETS

Product Code	Description
BB090613	304SS Side Action Flow Control Faucet
BB101200-SS	Chill-Max 304SS European Style Faucet
BB101202-SS	Chill-Max 304SS European Style Flow Control Faucet



BB101202-SS

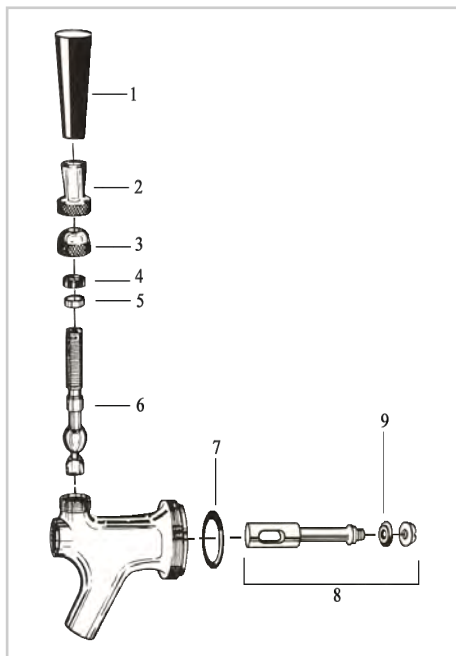

DOMESTIC FAUCET REPLACEMENT PARTS

Product Code	Description
BB101255	#1 Black Faucet Knob
BB101260	#1 Chrome Plated Faucet Knob
BB101265	#2 Lever Collar
BB101264	#2 Brass Lever Collar
BB101266	#3 Lever Bonnet
BB101263	#3 Brass Lever Bonnet
BB101267	#4 Friction Washer
BB101268	#5 Ball Washer
BB101270	#6 Stainless Steel Lever
BB101271	#7 Coupling Washer
BB101272-SS	#8 304SS Shaft Assembly
BB101262	#9 Valve Seat

■ Tap Handles



BB101260



BB101260-XL



BB100301-B



BB100301-C



BB101255



BB101261-BLK

TAP HANDLES

Product Code	Description
BB101255	Black Plastic Tap Handle - 2 3/4" Tall
BB101260	Chrome Metal Tap Handle - 2 1/2" Tall
BB101260-XL	Chrome Alloy Tap Handle - 2 1/2" Tall
BB101261-BLK	Black Plastic Tap Handle - 3 1/4" Tall
BB100301-B	Ergo Black Plastic Tap Handle - 4" Tall
BB100301-C	Ergo Chrome Plastic Tap Handle - 4" Tall



BB700405



BB700415

FAUCET LOCKS

Product Code	Description
BB700405	Faucet Lock for Standard USA Faucet
BB700415	Perlick Chrome Faucet Lock



CP101550



CP101525

SPOUT CAPS & PLUG

Product Code	Description
CP101550	Faucet Spout Cap for Domestic Faucets
CP101555	Faucet Spout Cap for European Faucets with SS Nozzles
CP101525	Brush & Plug Keep Beer Faucets Clean

FAUCET CLEANING BRUSH

Product Code	Description
CP101712	8" x 3/4" Cleaning Brush



CP101712



CP150980



CP151031

STAINLESS STEEL CLEANING CANS

Product Code	Description
CP150980	9L 2 Head SS Cleaning Can w/ 2 "D" System Valves
CP151031	18L 4 Head SS Cleaning Can w/ 4 "D" System Valves

* Custom configurations available: choose from "A", "G", "S" & "U" Valves

* Custom printed vinyl cleaning can wraps available. Contact sales.

VANTAGE SYNERGY

REVOLUTIONARY NON-CAUSTIC BEVERAGE SYSTEM CLEANER

Save time and keep patrons safe with this new, non-toxic formula.



A revolutionary non-caustic beverage system cleaner, Vantage Synergy's non-toxic formula saves you time and keeps your patrons safe.

Stocked & Distributed by CBS & Chill-Max, please contact our sales team today to request a sample or to get more information!

SPECIAL FEATURES

- ✓ Reduce cleaning times by up to 50%
- ✓ Triple zero health & safety rating
- ✓ No hazardous goods shipping charge
- ✓ Improve personal and customer safety
- ✓ Reduce property damage and injury liability claims
- ✓ Biodegradable chemistry limits waste water concerns

NON-CAUSTIC | NON-CORROSIVE | NON-HAZARDOUS

Product Code	Description
CP102200	32oz Biomass Remover

Product Code	Description
CP102210	32oz Accelerator

Product Code	Description
CP102220	32oz Demineralizer



CP101770-5



CP101771



CP101765

POWDER LINE CLEANERS

Product Code	Description
CP101770-5	5lb Super "No Rinse" Powder Line Cleaner
CP101771	40lb Super "No Rinse" Powder Line Cleaner
CP101765	40lb PLC Powder Line Cleaner



X 225



CP103100



CP103145

TM DESANA IC - COLOR CHANGE TECHNOLOGY

Product Code	Description
CP103100	TM Desana Max Powder Line Cleaner - 1.9oz Packet
CP103105	TM Desana Max Powder Line Cleaner - Case of 225 Packets
CP103145	4 Litre Desana IC Liquid Line Cleaner



CP103105



MP900105

LIQUID LINE CLEANERS

Product Code	Description
MP900105	4 Litre Benefit Liquid Cleaner

■ Trunkline



Taped Jacket Trunkline



- 3/4" Closed Cell Foam Insulation
- Foil Wrap
- Moisture Barrier Wrap
- Tubing lengths cut to order
- Color Coded Glycol Tubes
- Individually Identified Product Tubes
- Cabled for Maximum Flexibility

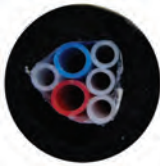

BT060125

1/4" ID TRUNKLINE - .30 LBS OF RESTRICTION PER FOOT

Product Code	Cabled	Tubing	Product Tubes	ID	Glycol Tubes	ID	Bundle OD
BT040125	X	Duoflex	2	1/4"	2	3/8"	2 3/4"
BT060125	X	Duoflex	4	1/4"	2	3/8"	2 3/4"
BT086225	X	Duoflex	6	1/4"	2	3/8"	2 3/4"
BT1612425	✓	Duoflex	12	1/4"	4	3/8"	3 1/2"
BT2016425	✓	Duoflex	16	1/4"	4	3/8"	4"



BT042257

5/16" ID TRUNKLINE - .10 LBS OF RESTRICTION PER FOOT

Product Code	Cabled	Tubing	Product Tubes	ID	Glycol Tubes	ID	Bundle OD
BT042257	X	Hi-Gloss	2	5/16"	2	3/8"	2 3/4"
BT064257	X	Hi-Gloss	4	5/16"	2	3/8"	2 3/4"
BT086257	X	Hi-Gloss	6	5/16"	2	3/8"	3"
BT108257	X	Hi-Gloss	8	5/16"	2	3/8"	3 1/4"
BT108259	X	Duoflex	8	5/16"	2	3/8"	3 1/4"
BT1410457	✓	Hi-Gloss	10	5/16"	4	3/8"	3 1/2"
BT1410459	✓	Duoflex	10	5/16"	4	3/8"	3 1/2"
BT1612457	✓	Hi-Gloss	12	5/16"	4	3/8"	3 3/4"
BT1612459	✓	Duoflex	12	5/16"	4	3/8"	3 3/4"
BT1814457	✓	Hi-Gloss	14	5/16"	4	3/8"	4"
BT1814459	✓	Duoflex	14	5/16"	4	3/8"	4"
BT2016457	✓	Hi-Gloss	16	5/16"	4	3/8"	4 1/4"
BT2016459	✓	Duoflex	16	5/16"	4	3/8"	4 1/4"



BT1612487

3/8" ID TRUNKLINE - .06 LBS OF RESTRICTION PER FOOT

Product Code	Cabled	Tubing	Product Tubes	ID	Glycol Tubes	ID	Bundle OD
BT042287	X	Hi-Gloss	2	3/8"	2	3/8"	2 3/4"
BT064287	X	Hi-Gloss	4	3/8"	2	3/8"	2 3/4"
BT086287	X	Hi-Gloss	6	3/8"	2	3/8"	3"
BT108287	X	Hi-Gloss	8	3/8"	2	3/8"	3 1/4"
BT1410487	✓	Hi-Gloss	10	3/8"	4	3/8"	3 1/2"
BT1410489	✓	Duoflex	10	3/8"	4	3/8"	3 1/2"
BT1612487	✓	Hi-Gloss	12	3/8"	4	3/8"	3 3/4"
BT1612489	✓	Duoflex	12	3/8"	4	3/8"	3 3/4"
BT1814487	✓	Hi-Gloss	14	3/8"	4	3/8"	4"
BT2016487	✓	Hi-Gloss	16	3/8"	4	3/8"	4 1/4"
BT2016489	✓	Duoflex	16	3/8"	4	3/8"	4 1/4"



PVC Fire Rated Jacket Trunkline

- 3/4" Closed Cell Foam Insulation
- Foil Wrap
- Moisture Barrier Wrap
- Tubing lengths cut to order
- Color Coded Glycol Tubes
- Individually Identified Product Tubes
- Cabled for Maximum Flexibility

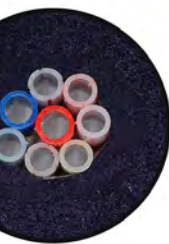

BT086290

1/4" ID TRUNKLINE - .30 LBS OF RESTRICTION PER FOOT

Product Code	Cabled	Tubing	Product Tubes	ID	Glycol Tubes	ID	Bundle OD
BT2016439	✓	Duoflex	16	1/4"	4	3/8"	4"

5/16" ID TRUNKLINE - .10 LBS OF RESTRICTION PER FOOT

Product Code	Cabled	Tubing	Product Tubes	ID	Glycol Tubes	ID	Bundle OD
BT042260	X	Hi-Gloss	2	5/16"	2	3/8"	2 3/4"
BT064260	X	Hi-Gloss	4	5/16"	2	3/8"	2 3/4"
BT086260	X	Hi-Gloss	6	5/16"	2	3/8"	3"
BT108629	X	Hi-Gloss	8	5/16"	2	3/8"	3 1/4"
BT1410460	✓	Hi-Gloss	10	5/16"	4	3/8"	3 1/2"
BT1410469	✓	Duoflex	12	5/16"	4	3/8"	3 1/2"
BT1612460	✓	Hi-Gloss	12	5/16"	4	3/8"	3 3/4"
BT1612469	✓	Duoflex	12	5/16"	4	3/8"	3 3/4"
BT1814460	✓	Hi-Gloss	14	5/16"	4	3/8"	4"
BT1814469	✓	Duoflex	14	5/16"	4	3/8"	4"
BT2016460	✓	Hi-Gloss	16	5/16"	4	3/8"	4"
BT2016469	✓	Duoflex	16	5/16"	4	3/8"	4"

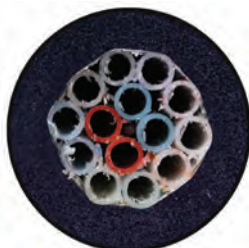

BT1410499

3/8" ID TRUNKLINE - .06 LBS OF RESTRICTION PER FOOT

Product Code	Cabled	Tubing	Product Tubes	ID	Glycol Tubes	ID	Bundle OD
BT042290	X	Hi-Gloss	2	3/8"	2	3/8"	2 3/4"
BT064290	X	Hi-Gloss	4	3/8"	2	3/8"	2 3/4"
BT086290	X	Hi-Gloss	6	3/8"	2	3/8"	3"
BT086299	X	Duoflex	6	3/8"	2	3/8"	3"
BT108299	X	Hi-Gloss	8	3/8"	2	3/8"	3 1/4"
BT1410490	✓	Hi-Gloss	10	3/8"	4	3/8"	3 1/2"
BT1410499	✓	Duoflex	10	3/8"	4	3/8"	3 1/2"
BT1612490	✓	Hi-Gloss	12	3/8"	4	3/8"	3 3/4"
BT1612499	✓	Duoflex	12	3/8"	4	3/8"	3 3/4"
BT1814490	✓	Hi-Gloss	14	3/8"	4	3/8"	4"
BT1814499	✓	Duoflex	14	3/8"	4	3/8"	4"
BT2016499	✓	Duoflex	16	3/8"	4	3/8"	4"

Tubing

VINYL TUBING

Product Code	Description
BT385187	3/16" ID x 7/16" OD Vinyl Tubing, Clear, 100'
BT385825	1/4" ID x 1/2" OD Vinyl Tubing, Clear, 100'
BT385804	5/16" ID x 9/16" OD Vinyl Tubing, Clear, 100'
BT385840	5/16" ID x 9/16" OD Vinyl Tubing, Red, 100'
BT385860	5/16" ID x 9/16" OD Vinyl Tubing, Blue, 100'
BT385809	3/8" ID x 5/8" OD Vinyl Tubing, Clear, 100'



BT385840



BT385860



BT385809



BT386312

*Rated for 250 PSI

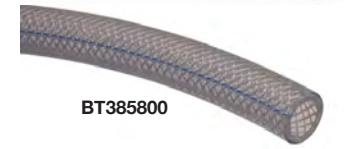

BT385800

PVC BRAIDED HOSE

Product Code	Description
BT144500	1/4" ID x 1/2" OD PVC Braided Hose, Clear, 100'
BT385800	5/16" ID x 9/16" OD PVC Braided Hose, Clear, 100'
BT386312-100*	5/16" ID x 9/16" OD PVC Braided Hose, Red, 100'
BT386312-500*	5/16" ID x 9/16" OD PVC Braided Hose, Red, 500'
BT385807	3/8" ID x 5/8" OD PVC Braided Hose, Clear, 100'
BT500650	1/2" ID x 3/4" OD PVC Braided Hose, Clear, 100'

BARRIER TUBING

Product Code	Description
BT143900	1/4" ID x 3/8" OD Barrier Tubing, Natural, 500'
BT144750	1/4" ID x 0.420" OD Barrier Braided Hose, White, 500'
BT384900	5/16" ID x 7/16" OD Barrier Tubing, Natural, 500'
BT385100	3/8" ID x 1/2" OD Barrier Tubing, Natural, 500'



BT143900

NSF FLEXIBLE TOTAL BARRIER TUBING

Product Code	Description
BT381187-100	3/16" ID x 7/16" OD NSF Total Barrier Tubing, Clear, 100'
BT381187-500	3/16" ID x 7/16" OD NSF Total Barrier Tubing, Clear, 500'
BT381375-100	3/8" ID x 5/8" OD NSF Total Barrier Tubing, Clear, 100'
BT381375-500	3/8" ID x 5/8" OD NSF Total Barrier Tubing, Clear, 500'



BT381187-500

- FDA Compliant and NSF-51 Certified
- Excellent gas barrier properties
- Can be used with all products up to 45% ABV
- Phthalate Free: Prop 65 compliant, contains no PVC
- Extreme low temperature, stays flexible up to -4°F/20°C
- Zero flavor transfer: reacts like flexible Stainless Steel

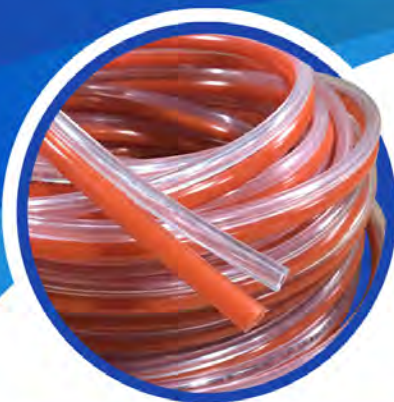

SKIP BOND TUBING

CBS Skip Bond Tubing is an innovative solution that will keep the walk-in fridge tidy and organized.

FEATURES

- Available with Barrier or PVC Tubing
- Bonded & Gapped at 6" intervals to keep lines organized
- No tape or cable ties required
- 100' & 1000' lengths

BULK UP AND SAVE!

Bulk Discounts on Beer System Components



See the full list of eligible products here, or reach out to your Sales Rep for more information!

Purchase your most-used beverage system components in bulk to receive a quantity discount.

Includes select fittings, faucets, couplers, tubing, tape, beer pumps & more! Perfect for upgrading beverage dispense systems with 304SS components and fittings.



Fittings for: Beer, Soda, Wine, Water, Cocktails, & Coffee Dispense

Bulk Up & Save Program

STAINLESS STEEL STEPLESS CLAMPS

Product Code	Size
OC065	6.5mm
OC070	7.0mm
OC087	8.7mm
OC095	9.5mm
OC100	10.0mm
OC105	10.5mm
OC113	11.3mm

Product Code	Size
OC118	11.8mm
OC123	12.3mm
OC128	12.8mm
OC133	13.3mm
OC140	14.0mm
OC145	14.5mm
OC157	15.7mm

Product Code	Size
OC162	16.2mm
OC170	17.0mm
OC185	18.5mm
OC198	19.8mm
OC210	21.0mm
OC226	22.6mm
OC241	24.1mm



OC065



OC157



OC185



MP559999

See page 46 for clamp pincers & tools.

STAINLESS STEEL GEAR CLAMPS

Product Code	Size
OC99-04	#4 - 5/8" Max
OC99-05	#5 - 3/4" Max
OC99-06	#6 - 7/8" Max



OC99-04



OC99-05



OC99-06

PLATED SWIVEL NUTS

Product Code	Size
SF149265	1/4"
SF389375	3/8"



SF149265

PLASTIC BARB PLUG

Product Code	Size
SF147251	1/4", 3/8" & 1/2"



SF147251

Beverage System Fittings

STAINLESS STEEL HOSE BARB FITTINGS



SF792200

U-BENDS

Product Code	Size
SF792200	1/4" x 1/4"
SF792300-XLG	3/8" x 3/8"
SF792300-XSM	3/8" x 3/8"
SF792400-X	1/2" x 1/2"



SF792265

U-BENDS WITH STEM

Product Code	Size
SF792265	1/4" x 1/4" x 1/4"
SF792290-X	5/16" x 5/16" x 5/16"
SF792375	3/8" x 3/8" x 1/4"
SF792750-X	3/8" x 3/8" x 3/8"



SF147265

STEMS

Product Code	Size
SF147265	1/4" for 1/4" Nut
SF147375	1/4" for 3/8" Nut
SF387375	3/8" for 3/8" Nut

SWIVEL NUT ADAPTER

Product Code	Size
SF147169	1/4" Nut x 3/8" Barb



SF147169



SF800125

Y-TEES

Product Code	Size
SF800125	1/4" x 1/4" x 1/4"
SF800375	3/8" x 3/8" x 3/8"



SF147725-X

SPLICERS

Product Code	Size
SF087625	1/8" x 1/8"
SF147725-X	1/4" x 1/4"
SF312312-X	5/16" x 5/16"
SF387735-X	3/8" x 3/8"
SF500750-X	1/2" x 1/2"



SF087725

REDUCERS

Product Code	Size
SF087725	1/4" x 1/8"
SF147738-X	3/8" x 1/4"
SF312250-X	5/16" x 1/4"
SF387312-X	3/8" x 5/16"
SF387750-X	1/2" x 3/8"



SF143325-X

EQUAL TEES

Product Code	Size
SF143325-X	1/4" x 1/4" x 1/4"
SF300312-X	5/16" x 5/16" x 5/16"
SF383335-X	3/8" x 3/8" x 3/8"
SF500555-X	1/2" x 1/2" x 1/2"

Push to Connect Fittings with Shut-Off Feature

CPC FITTINGS - QUICK DISCONNECT SHUT-OFFS



QD700422

Product Code	Description
QD700421	1/4" ID Hose Barb Socket - Female
QD700422	3/8" ID Hose Barb Socket - Female
QD700426	1/4" ID Hose Barb Insert - Male
QD700427	3/8" ID Hose Barb Insert - Male



QD700427

ELBOWS

Product Code	Size
SF250250	1/4" x 1/4"
SF300300-X	5/16" x 5/16"
SF380380-X	3/8" x 3/8"
SF500500	1/2" x 1/2"



SF250250



SF383385-X

BRANCH TEES

Product Code	Size
SF383385-X	1/4" (2) x 3/8"

Beverage System Fittings

304SS TAILPIECES

Product Code	Size
BB101506SS	3/16"
BB101507SS	1/4"
BB101510SS	5/16"
BB101508SS	3/8"
BB101509SS	1/2"



BB101507SS

NUTS & WASHER

Product Code	Description
BB101536-SS	SS Hex Nut
BB101505	Wing Nut
BB101030	Hex Nut Washer



BB101505

304SS 90° TAILPIECES

Product Code	Size
BB101531-A3	3/16"
BB10153	1/4"
BB101533	5/16"
BB101534	3/8"



BB101533



BB101530



BB101531



BB101535



BB101545

WALL BRACKETS

Product Code	Size
BB101530	3/8" Barb (2) SS Wall Bracket
BB101531	3/8" Barb (2) SS Wall Bracket
BB101531-L	3/8" Barb (2) SS Wall Bracket

Product Code	Size
BB101535	Beer Thread x 3/8" Barb SS Wall Bracket
BB101537	"U" Bend with Stem 3/8" Barb (3) SS Wall Bracket
BB101543	Beer Thread (2) x 3/8" Barb
BB101545	Beer Thread (2)



BB101503



BB101502



BB101501



BB101496-SS



MP551837

Y'S & SHUT-OFFS

Product Code	Size
BB101501	Beer Thread (3) Shut-Off
BB101502	Beer Thread (3) "Y"
BB101503	Beer Thread (3) "Y"

Product Code	Size
BB101496-SS	Beer Thread (2) Shut-Off
MP551825	1/4" Barb (2) Shut-Off

Product Code	Size
MP551834	5/16" Barb (2) Shut-Off
MP551837	3/8" Barb (2) Shut-Off

Push to Connect Fittings

TUBE TO HOSE STEMS

Product Code	Description
QD100695	3/8" OD Stem x 1/4" Barb
QD100697	3/8" OD Stem x 5/16" Barb
QD100700	3/8" OD Stem x 3/8" Barb



QD100700

TUBE TO HOSE ELBOWS

Product Code	Description
QD100764	3/8" OD Stem x 5/16" Barb
QD100765	3/8" OD Stem x 3/8" Barb



QD100764



QD700725

CHECK VALVES

Product Code	Description
QD700725	3/8" OD Tube x 3/8" OD Tube
QD700730	1/2" OD Tube x 1/2" OD Tube

Beverage Dispense Tools

Tools

FAUCET WRENCHES

Product Code	Description
BB101719	Faucet Wrench
BB101721	Deluxe Faucet Wrench
BB101727	6 in 1 Perlick Combination Wrench



TOWER WRENCH

Product Code	Description
BB101722	SS Tower Wrench



CO2 WRENCH

Product Code	Description
CO898804	CO2 Wrench



CLAMP PINCERS

Product Code	Description
MP559995	Straight Jaw Pincer
MP559999	Side Jaw Pincer
MP559996	Oetiker Straight Jaw Pincer
MP560000	Oetiker Side Jaw Pincer



THERMOMETERS

Product Code	Description
BB330021	Digital Thermometer
BB330025	Taylor Digital Waterproof Thermometer



POCKET HOSE CUTTER

Product Code	Description
MP559970	Pocket Hose Cutter





REX01124

Direct Draw Beer Dispensers

DIRECT DRAWS - NO TOWER(S)

Product Code	Description
REX01124	1 Door, 24 1/4" W x 41 3/4" H x 30 5/8" D
REX01158	2 Door, 59 1/2" W x 36 7/8" H x 28 5/8" D
REX01168	2 Door, 69 1/2" W x 36 7/8" H x 28 5/8" D
REX01178	3 Door, 80" W x 36 7/8" H x 28 5/8" D

DIRECT DRAWS WITH TOWER(S)

Product Code	Description
REX01124-1T	1 Tap, 1 Door, 24 1/4" W x 41 3/4" H x 30 5/8" D
REX01124-2T	2 Tap, 1 Door, 24 1/4" W x 41 3/4" H x 30 5/8" D
REX01124-3T	3 Tap, 1 Door, 24 1/4" W x 41 3/4" H x 30 5/8" D
REX01158-2T	2 Tap, 2 Door, 59 1/2" W x 36 7/8" H x 28 5/8" D
REX01158-3T	3 Tap, 2 Door, 59 1/2" W x 36 7/8" H x 28 5/8" D
REX01158-4T	4 Tap, 2 Door, 59 1/2" W x 36 7/8" H x 28 5/8" D
REX01168-3T	3 Tap, 2 Door, 69 1/2" W x 36 7/8" H x 28 5/8" D
REX01168-4T	4 Tap, 2 Door, 69 1/2" W x 36 7/8" H x 28 5/8" D
REX01178-4T	4 Tap, 3 Door, 80" W x 36 7/8" H x 28 5/8" D
REX01178-5T	5 Tap, 3 Door, 80" W x 36 7/8" H x 28 5/8" D



REX01158-2T



REX01178-4T



BB101416

AIR COOLED "T" TOWERS

Product Code	Description
BB101413	3T BSS T-Tower with 304SS Taps
BB101414	4T BSS T-Tower with 304SS Taps
BB101415	5T BSS T-Tower with 304SS Taps
BB101416	6T BSS T-Tower with 304SS Taps



BB101465-06

DIRECT DRAW 3" DIA DOUBLE PEDESTAL TOWER WITH 304SS TAPS

Product Code	Taps	Finish	Cooling	Length	Ped Center
BB101463-04	4	Brushed SS	Air	20"	12"
BB101463-05	5	Brushed SS	Air	20"	12"
BB101465-06	6	Brushed SS	Air	24"	12"
BB101465-08	8	Brushed SS	Air	24"	12"
BB101467-04	4	Brushed SS	Air	20"	13"
BB101467-05	5	Brushed SS	Air	20"	13"
BB101469-06	6	Brushed SS	Air	24"	13"
BB101469-08	8	Brushed SS	Air	24"	13"

Direct Draw Beer Dispensers

3" DIA. COLUMN TOWERS

Product Code	Description
BB101402	1T PSS 3" Dia. Column - w/ Tap
BB101406	2T PSS 3" Dia. Column - w/ Tap
BB101419	3T PSS 3" Dia. Column - w/ Tap



BB101402



BB101406



BB101419



RE801012-CO2

DIRECT DRAW TAPPING KITS

Product Code	Description
RE801012-CO2	CO2 1T Direct Draw Tapping Kit
RE801014-CO2	CO2 2T Direct Draw Tapping Kit
RE801015-CO2	CO2 3T Direct Draw Tapping Kit
RE801016-CO2	CO2 4T Direct Draw Tapping Kit
RE801012-N2	N2 1T Direct Draw Tapping Kit
RE801014-N2	N2 2T Direct Draw Tapping Kit
RE801015-N2	N2 3T Direct Draw Tapping Kit
RE801016-N2	N2 4T Direct Draw Tapping Kit

DIRECT DRAW GLYCOL COOLING KIT

Cool up to 5 Faucets with our innovative Direct Draw Glycol Recirculation Kit.

Product Code	Description
BB989702	CBS/Chill-Max Direct Draw Cooling Kit - 115V



BB989702

Bar Back Coolers

BLACK ENAMEL CABINET & SS TOP

Product Code	Description
RE607158-A	2 Door, 59 1/2" W x 36 7/8" H x 29" D
RE607168-A	2 Door, 69 1/2" W x 36 7/8" H x 29" D
RE607178-A	3 Door, 80" W x 36 7/8" H x 29" D
RE607194-A	3 Door, 95 1/2" W x 36 7/8" H x 29" D



RE607079

BLACK ENAMEL CABINET & SS TOP WITH GLASS DOORS

Product Code	Description
RE607158-AG	2 Door, 58" W x 38 1/2" H x 31 1/8" D



RE607158-AG



MP099509

MP099518

304SS "D" SYSTEM COCKTAIL TANKS

Product Code	Description
MP099509	A.E.B 304SS 2.5G "D" System Cocktail Tank
MP099518	A.E.B 304SS 5G "D" System Cocktail Tank

304SS BALL LOCK TRANSFER TANKS

Product Code	Description
MP099900	A.E.B Ball Lock 2.5G SS Tank
MP099910	A.E.B Ball Lock 5G SS Tank
MP099911	A.E.B Ball Lock 5G SS Tank w/ Double Handle



MP099900

MP099910

MP099911

TANK REPLACEMENT PARTS

Product Code	Description
MP099950	Transfer Tank Lid w/ Safety
MP100150	Transfer Tank Lid w/ Gas Inlet & PRV
MP099952	Transfer Tank/Cleaning Tank PRV
MP099955	Tank Lid O'Ring
MP099965	Ball Lock Post O'Ring (Pepsi)



MP099950



MP100150



MP099952



MP099955



MP099965



MP099950



MP100150

TANK QUICK DISCONNECT FITTINGS

Product Code	Description
MP110001	Ball Lock w/ 1/4" Barb - Gas
MP110002	Ball Lock w/ 1/4" Barb - Liquid
MP110003	Ball Lock w/ 1/4" MFL - Gas
MP110004	Ball Lock w/ 1/4" MFL - Liquid
MP110009	Ball Lock w/ 3/8" Barb - Gas
MP110010	Ball Lock w/ 3/8" Barb - Liquid
MP100000	Pin Lock w/ 1/4" Barb - Liquid
MP100099	Pin Lock w/ 1/4" Barb - Gas



MP110001

MP110002

MP110003

MP110004

MP100099

MP100000

WATER COOLING & DISPENSING

Cooling Systems

FLASH COOLERS - CHILL BEVERAGES TO THE POINT OF DISPENSE

Product Code	Description
BB900248	Chill-Max Flash Cooler w/ 2-SS Product Cooling Coils & Recirculation Pump - 115V
BB900316	Chill-Max Flash Cooler w/ 3-SS Product Cooling Coils & Recirculation Pump - 115V



BB900248

REMOTE WATER FLASH COOLER - CARBONATE & CHILL WATER TO THE POINT OF DISPENSE

Product Code	Description
WF565355	Chill-Max Remote Cooler w/Built-In Cold Carbonator and Recirculation Pump - 115 V



BB900254



WF565176

PRE-COOLED CARBONATOR

Product Code	Description
WF565176	Chill-Max Pre-Cooled Carbonator w/Insulated Bowl - 115V

COUNTERTOP WATER FLASH COOLER - CARBONATE, CHILL & DISPENSE

Product Code	Description
WF565072	Chill-Max Counter Top Chiller/Dispenser w/ Built-In Cold Carbonator - 115V Serve Premium Filtered Chilled and Sparkling Water on Demand



WF565072

REMOTE WATER FLASH COOLER - DRY REFRIGERATION FEATURE

Product Code	Description
WF565329	Chill-Max Remote Dry Cooler w/Built-In Carbonator - 115V

Mongoose

MONGOOSE WITH EURO 304SS QUIX FLOW CONTROL FAUCETS



WF107140C-QX

WF107150C-QX

Product Code	Taps	Finish	Cooling	Drip Tray
WF107140C-QX	1	Chrome	Air	10"
WF107150C-QX	2	Chrome	Air	10"
WF107160C-QX	3	Chrome	Air	12"
WF107140C-QXCK	1	Chrome	Glycol	10"
WF107150C-QXCK	2	Chrome	Glycol	10"
WF107160C-QXCK	3	Chrome	Glycol	12"

MINI MONGOOSE WITH EURO 304SS QUIX FLOW CONTROL FAUCETS

Product Code	Taps	Finish	Cooling	Drip Tray
WF107280C-QX	1	Chrome	Air	10"
WF107280C-QX	1	Chrome	Glycol	10"



WF107280C-QX

MEDIUM MONGOOSE WITH EURO 304SS QUIX FLOW CONTROL FAUCETS

Product Code	Taps	Finish	Cooling	Drip Tray
WF107290C-QX	1	Chrome	Air	10"
WF107295C-QX	2	Chrome	Air	10"
WF107290C-QXCK	1	Chrome	Glycol	10"
WF107295C-QXCK	2	Chrome	Glycol	10"



WF107146C-650

WF107156C-650

MONGOOSE WITH PERLICK 650SS FLOW CONTROL FAUCETS

Product Code	Taps	Finish	Cooling	Drip Tray
WF107146C-650	1	Chrome	Air	10"
WF107156C-650	2	Chrome	Air	10"
WF107166C-650	3	Chrome	Air	12"
WF107146C-650CK	1	Chrome	Glycol	10"
WF107156C-650CK	2	Chrome	Glycol	10"
WF107166C-650CK	3	Chrome	Glycol	12"

MINI MONGOOSE WITH PERLICK 650SS FLOW CONTROL FAUCETS

Product Code	Taps	Finish	Cooling	Drip Tray
WF107286C-650	1	Chrome	Air	10"
WF107286C-650CK	1	Chrome	Glycol	10"



WF107306C-650

WF107306C-650CK

MEDIUM MONGOOSE WITH PERLICK 650SS FLOW CONTROL FAUCETS

Product Code	Taps	Finish	Cooling	Drip Tray
WF107306C-650	1	Chrome	Air	10"
WF107310C-650	2	Chrome	Air	10"
WF107306C-650CK	1	Chrome	Glycol	10"
WF107310C-650CK	2	Chrome	Glycol	10"

304SS FLOW CONTROL FAUCETS

Product Code	Description
BB101214-SS	Perlick 650 304SS Flow Control Faucet
WF101231	304SS Euro Quix Flow Control Faucet w/ Shank



BB101214-SS



WF101231

Water Filters

WATER ACCESSORIES

Product Code	Description
MP555017	50PSI Water Regulator with 3/8" Barbed Fittings
MP555018	30PSI Water Regulator with 3/8" Barbed Fittings
MP551720	Watts SS SD3-LS Backflow - 3/8" MFL x 3/8" MF
MP551722	Watts SS 9BD Backflow - 3/8" MFL x 3/8" MF
WF100013-R	Water Block Low Volume Leak Safety Device



MP555017



MP551722



WF006530



WF006545

Water Filters

WATER FILTER ACCESSORIES

Product Code	Description
WF006530	3M VH3 - 3/8" FNPT, Valve-In-Head
WF006545	3M VH3 - 3/8" FNPT, Valve-In-Head w/ Shroud & Plug

REPLACEMENT WATER FILTERS

Product Code	Description
WF006310	3M HF60 Filter (0.2micron/35,000 gallon)
WF006320	3M HF90 Filter (0.2micron/54,000 gallon)



WF006310



WF006320



WF006375

STANDARD WATER FILTER SYSTEM KITS WITH FLUSH

Product Code	Description
WF006375	3M HF60 Kit - Filter, Housing, Tubing & Fittings
WF006387	3M HF90 Kit - Filter, Housing, Tubing & Fittings

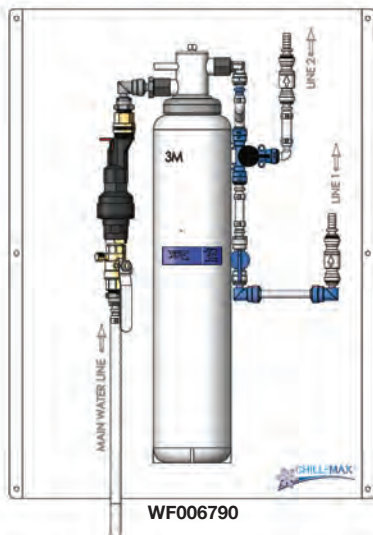

WF006790

PREMIUM WATER FILTER SYSTEM PANEL KITS

Product Code	Description
WF006760	3M HF60 Water Filter Panel System
WF006790	3M HF90 Water Filter Panel System

* Water filter system is completely plumbed and features an automatic excess water flow shut-off with metal gate valve. Contact sales for more product details.

Fresh water, always on tap.

Keep fresh water flowing to your equipment, no matter your location. The Flojet Bottled Water system allows you to connect to and pump water seamlessly from packaged water bottles.

Mount your pump panel on the wall and plumb it to your coffee machine, bottle fill stations, or other kitchen equipment to ensure fresh, clean water is always available.

Refresh your system with CBS & Chill-Max. Call today for more information on water dispense solutions.



BOTTLED WATER DISPENSERS

Product Code	Description
MP555070	Flojet Single Inlet Bottled Water Dispenser 0.6 GPM - 115V
MP555070-2A	Flojet Dual Inlet Bottled Water Dispenser 0.6 GPM - 115V
MP555128	Flojet Single Inlet Bottled Water & Accumulator Tank 1.6 GPM - 115V



MP555128



MP556108

CARBONATORS

Product Code	Description
MP556105	Standard Flow Carbonator ASSE 1022 - 115V
MP556108	McCann's Big Mac Carbonator ASSE 1022 - 115V



MP556105

80MM WATER MEDALLIONS

Product Code	Description
WF920210	"Chilled"
WF920212	"Chilled Sparkling"
WF902214	"Ambient"



82MM WATER MEDALLIONS

Product Code	Description
WF920220	"Chilled"
WF920222	"Chilled Sparkling"
WF920224	"Ambient"

TRAP-Z WATER TAP HANDLES

Product Code	Color	Print	Fitting
WF920021	White	"Chilled"	Chrome
WF920025	White	"Chilled Sparkling"	Chrome
WF920029	White	"Ambient"	Chrome



SHOTGUN 2.0 WATER TAP HANDLES

Product Code	Color	Print	Fitting
WF920001	White	"Chilled"	Chrome
WF920005	White	"Chilled Sparkling"	Chrome
WF920009	White	"Ambient"	Chrome



Flojet BIB Pumps

Flojet BIB Pumps



MP555250-S

FLOJET T5000 BIB PUMPS

Product Code	Description
MP555250-S	Gas Beverage Pump; 1/4" SS Syrup, Straight Gas
MP555253-L	Gas Beverage Pump; 1/4" SS Syrup, "L" Gas
MP555255-T	Gas Beverage Pump; 1/4" SS Syrup, "T" Gas
MP555370-S	Gas Beverage Pump; 3/8" SS Syrup, Straight Gas
MP555373-L	Gas Beverage Pump; 3/8" SS Syrup, "L" Gas
MP555375-T	Gas Beverage Pump; 3/8" SS Syrup, "T" Gas



MP555002

FLOJET BIB PUMP FITTINGS: PRODUCT

Product Code	Description
MP555001	SS 1/4" Straight Hose Barb Liquid Fitting
MP555002	SS 3/8" Straight Hose Barb Liquid Fitting



MP555003



MP555004

FLOJET BIB PUMP FITTINGS: GAS

Product Code	Description
MP555003	Brass 1/4" Elbow Hose Barb Inlet with Shut-Off
MP555004	Brass 1/4" "T" Hose Barb Inlet with Shut-Off
MP555008	Brass 1/4" Straight Hose Barb Inlet with Shut-Off
MP555112	Brass 1/4" Offset "T" Hose Barb with Shut-Off



MP555112

FLOJET PUMP ACCESSORIES



MP555012

Product Code	Description
MP555012	Transfer Valve - Regular
MP555015	Strainer - 3/8" Barb Inlet & Outlet, 40 Mesh SS Screen
MP555017	50PSI Water Regulator with 3/8" Barbed Fittings
MP555018	30PSI Water Regulator with 3/8" Barbed Fittings
MP555115	15PSI Water Regulator with 3/8" Barbed Fittings



MP555015

For Cold Plates, Bar Gun Fittings, BIB Racks and other Post-Mix related products please check out our website or contact sales for assistance.

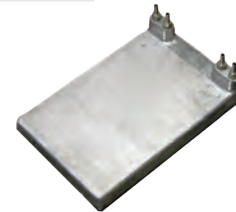

POST-MIX BAR GUNS

Product Code	Description
MP883789	Rattler 6 Product Post Mix Juice Gun - 48" Whip
MP883775	Rattler 10 Button Post-Mix Bar Gun - 6 Carb 2 Non-Carb
MP883781	Rattler 12 Button Post-Mix Bar Gun - 6 Carb 4 Non-Carb
MP883789	Rattler 14 Button Post-Mix BAR Gun - 6 Carb 6 Non-Carb



SODA BUNDLE

Product Code	Description
BT06000-100	6 Line - 1/4" ID Poly Tubes - 100' Coil
BT100375	10 Line - 3/8" ID Barrier Tubes - 100' Coil
BT120375	12 Line - 3/8" ID Barrier Tubes - 100' Coil
BT141165	14 Line - 10 x 1/4" ID + 4 x 3/8" ID Barrier Tubes- 100' Coil

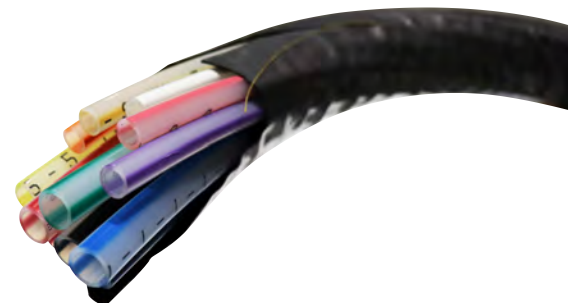

Special Event Dispense

304SS COILS

CBS 304SS Coils are continuously extruded, not welded, eliminating bacteria build up & extending coil life.

Combs separate SS tubes to allow water to circulate evenly throughout the coils.

Product Code	Description	Shape
CL106305	50' x 5/16" OD	Round
CL106310	50' x 5/16" OD - Left/Right	Square
CL106315	85' x 5/16" OD - Left/Right	Square
CL106320	120' x 5/16" OD - Left/Right - Includes an In-Line Flow Control - MP551064	Square
MP551064	304SS In-Line Flow Control 5/16" SS OD x 5/16" SS OD	N/A



CL106305



CL106310



CL106320



CL106315



MP551064



JOCKEY BOXES Featuring 304SS Coils & 304SS Parts

Product Code	Description
CL105420	48qt 1 Tap Jockey Box with 304SS 50' Coil and 304SS Parts
CL105430	48qt 2 Tap Jockey Box with 304SS 50' Coils and 304SS Parts
CL105423	48qt 1 Tap Jockey Box with 304SS 85' Coil and 304SS Parts
CL105433	48qt 2 Tap Jockey Box with 304SS 85' Coils and 304SS Parts
CL105425	48qt 1 Tap Jockey Box with 304SS 120' Coil and 304SS Parts
CL105435	48qt 2 Tap Jockey Box with 304SS 120' Coils and 304SS Parts



JOCKEY BOXES and PICNIC COOLERS with Custom Vinyl Wraps - Contact Sales for Details



CL195100

JOCKEY BOX TAPPING KIT WITH 304SS "D" SYSTEM KEG COUPLERS

Product Code	Description
CL195100	1 Tap Co2 Tapping Kit with 304SS "D" Keg Coupler
CL195105	2 Tap Co2 Tapping Kit with 304SS "D" Keg Coupler
CL195110	3 Tap Co2 Tapping Kit with 304SS "D" Keg Coupler
CL195115	4 Tap Co2 Tapping Kit with 304SS "D" Keg Coupler

ALUMINUM CO2 CYLINDERS

Product Code	Description
CO888990	5lb Aluminum Co2 Cylinder
CO888993	10lb Aluminum Co2 Cylinder
CO889000	20lb Aluminum Co2 Cylinder



CO888990



CO888993



CO889000